

DECLARACIÓN DE PRESTACIONES

DoP 0329

para taco largo fischer SXR/SXRL (Anclajes de plástico para el uso en hormigón y mampostería)

ES

1. Código de identificación única del producto tipo: DoP 0329
2. Usos previstos: Anclaje de nylon de uso universal para hormigón y fábrica de ladrillo y bloque en aplicaciones no estructurales (base de anclaje grupo a b, c, d), véase el apéndice, especialmente los anexos B1 - B7.
3. Fabricante: fischerwerke GmbH & Co. KG, Klaus-Fischer-Str. 1, 72178 Waldachtal, Alemania
4. Representante autorizado: -
5. Sistemas de evaluación y verificación de la constancia de las prestaciones (EVCP): 2+
6. Documento de evaluación europeo: EAD 330284-00-0604, Edition 12/2020
Evaluación técnica europea: ETA-07/0121; 2022-12-20
Organismo de evaluación técnica: DIBt- Deutsches Institut für Bautechnik
Organismos notificados: 2873 TU Darmstadt

7. Prestaciones declaradas:

Seguridad en caso de incendio (BWR 2)

Reacción al fuego: Clase A1

Resistencia al fuego: Anexo C2

$N_{Rk,s,fi} = \text{NPD}$; $N_{Rk,p,fi} = \text{NPD}$

Resistencia mecánica y estabilidad (BWR 4)

Resistencia a rotura del acero sometido a tracción: Anexo C1

Resistencia a rotura del acero o del polímero a cortante: Anexo C1

Resistencia al arranque o rotura del hormigón o del polímero, bajo carga a tracción (base de anclaje grupo a): Anexo C1

$V_{Rk,pol} = \text{NPD}$

Resistencia en cualquier dirección de carga sin brazo de palanca (base de anclaje grupos b, c, d): véase el apéndice, especialmente los anexos C16 - C45

Distancia al borde y entre ejes (base de anclaje grupo a): Anexo B4

Distancia al borde y entre ejes (base de anclaje grupos b, c, d): Anexos B5, B6

Desplazamientos bajo carga a corto y largo plazo: Anexo C2

Durabilidad: Anexos A3, B1, B2

8. Documentación técnica adecuada o documentación técnica específica: -

Las prestaciones del producto identificado anteriormente son conformes con el conjunto de prestaciones declaradas. La presente declaración de prestaciones se emite, de conformidad con el Reglamento (UE) no 305/2011, bajo la sola responsabilidad del fabricante arriba identificado.

Firmado por y en nombre del fabricante por:



Dr.-Ing. Oliver Geibig, Director General Unidades de Negocio e Ingeniería
Tumlingen, 2023-01-17



Jürgen Grün, Director General de Química y Calidad

Esta DdR se ha preparado en distintos idiomas. En caso de que haya alguna controversia sobre la interpretación prevalecerá siempre la versión inglesa.

El Apéndice incluye información voluntaria y complementaria en idioma inglés que excede los requisitos legales (de idioma neutral).

Translation guidance Essential Characteristics and Performance Parameters for Annexes

Glosario de parámetros esenciales, característicos y de prestaciones para los anexos

Safety in case of fire (BWR 2)

Seguridad en caso de incendio (BWR 2)

1	Reaction to fire: Reacción al fuego:	-
2	Resistance to fire: Resistencia al fuego:	$N_{Rk,s,fi}$; $N_{Rk,p,fi}$; $F_{Rk,fi,90}$ [kN]

Mechanical resistance and stability (BWR 4)

Resistencia mecánica y estabilidad (BWR 4)

3	Resistance to steel failure under tension loading: Resistencia a rotura del acero sometido a tracción:	$N_{Rk,s}$ [kN]
4	Resistance to steel or polymer failure under shear loading: Resistencia a rotura del acero o del polímero a cortante:	$V_{Rk,s}$ [kN]; $M_{Rk,s}$ [Nm]; $V_{Rk,pol}$ [kN]
5	Resistance to pull-out or concrete failure or polymer failure under tension loading (base material group a) Resistencia al arranque o rotura del hormigón o del polímero, bajo carga a tracción (base de anclaje grupo a):	$N_{Rk,p}$ [kN] / $N_{Rk,pol}$ [kN]
6	Resistance in any load direction without lever arm (base material group b,c,d): Resistencia en cualquier dirección de carga sin brazo de palanca (base de anclaje grupos b, c, d):	F_{Rk} [kN]
7	Edge distance and spacing (base material group a) Distancia al borde y entre ejes (base de anclaje grupo a):	c_{cr} ; s_{cr} ; c_{min} ; s_{min} ; a ; h_{min} [mm]
8	Edge distance and spacing (base material group b,c,d): Distancia al borde y entre ejes (base de anclaje grupos b, c, d):	c_{min} ; s_{min} ; h_{min} [mm]
9	Displacements under short-term and long-term loading: Desplazamientos bajo carga a corto y largo plazo:	δ_0 ; δ_∞ [mm]

Aspects of durability

Durabilidad:

10	Durability: Durabilidad:	-
----	------------------------------------	---

Specific part

1 Technical description of the product

The fischer frame fixing in the range SXR 8, SXRL 8, SXR 10, SXRL 10 and SXRL 14 is a plastic anchor consisting of a plastic sleeve made of polyamide and an accompanying specific screw of galvanised steel, of galvanised steel with an additional organic layer or of stainless steel.

The plastic sleeve is expanded by screwing in the specific screw which presses the sleeve against the wall of the drilled hole.

The product description is given in Annex A.

2 Specification of the intended use in accordance with the applicable European Assessment Document

The performances given in Section 3 are only valid if the anchor is used in compliance with the specifications and conditions given in Annex B.

The verifications and assessment methods on which this European Technical Assessment is based lead to the assumption of a working life of the anchors of at least 50 years. The indications given on the working life cannot be interpreted as a guarantee given by the producer, but are to be regarded only as a means for choosing the right products in relation to the expected economically reasonable working life of the works.

3 Performance of the product and references to the methods used for its assessment

3.1 Safety in case of fire (BWR 2)

Essential characteristic	Performance
Reaction to fire	Class A1
Resistance to fire	See Annex C 2

3.2 Mechanical resistance and stability (BWR 4)

Essential characteristic	Performance
Resistance to steel failure under tension loading	See Annex C 1
Resistance to steel failure under shear loading	See Annex C 1
Resistance to pull-out or concrete failure under tension loading (base material group a)	See Annex C 1
Resistance in any load direction without lever arm (base material group b, c, d)	See Annexes C 16 – C 45
Edge distance and spacing (base material group a)	See Annex B 4
Edge distance and spacing (base material group b, c, d)	See Annex B 5 and B 6
Displacements under short-term and long-term loading	See Annex C 2
Durability	See Annex B 1 and B 2

4 Assessment and verification of constancy of performance (AVCP) system applied, with reference to its legal base

In accordance with European Assessment Document EAD 330284-00-0604 the applicable European legal act is: 97/463/EC.

The system to be applied is: 2+

The following standards and documents are referred to in this European Technical Assessment:

- EOTA European Assessment Document EAD 330284-00-0604, edition December 2020: Plastic anchors for redundant non-structural systems in concrete and masonry
- EOTA Technical Report TR 051, Edition April 2018: Recommendations for job site tests of plastic anchors and screws
- EOTA Technical Report TR 064, Edition May 2018: Design of plastic anchors in concrete and masonry
- EN 206:2013+A1:2016: Concrete – Specification, performance, production and conformity
- EN 771-1:2011+A1:2015: Specification for masonry units – Part 1: Clay masonry units
- EN 771-2:2011+A1:2015: Specification for masonry units – Part 2: Calcium silicate
- EN 771-3:2011+A1:2015: Specification for masonry units – Part 3: Aggregate concrete masonry units (dense and lightweight aggregates)
- EN 771-4:2011+A1:2015: Specification for masonry units – Part 4: autoclaved aerated concrete masonry units
- EN 998-2:2010: Specification for mortar for masonry - Part 2: Masonry mortar
- EN 1993-1-4:2006 + A1:2015: Eurocode 3: Design of steel structures – Part 1-4: General rules - Supplementary rules for stainless steels
- EN 12602:2016: Prefabricated reinforced components of autoclaved aerated concrete
- EN ISO 4042:2018: Fasteners – Electroplated coating systems

SXR

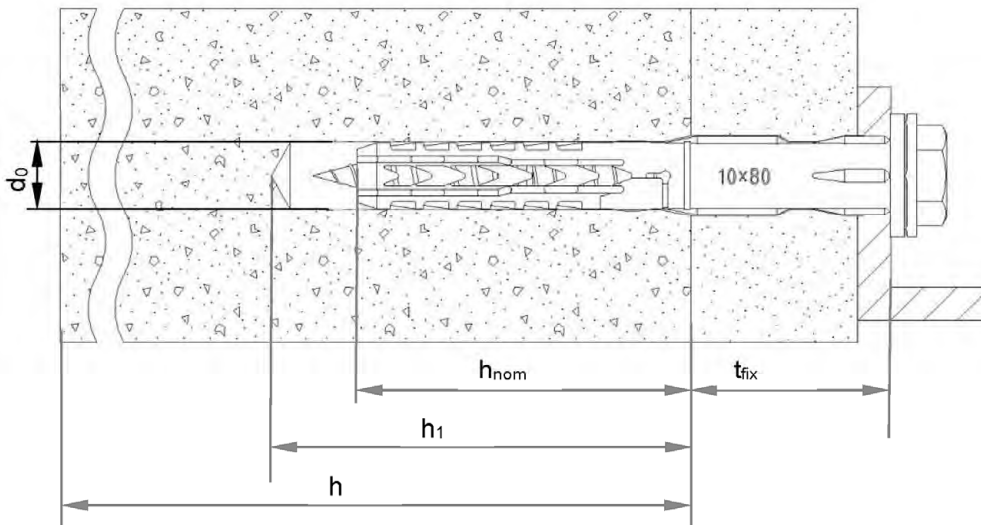

SXRL (e.g. with h_{nom2})

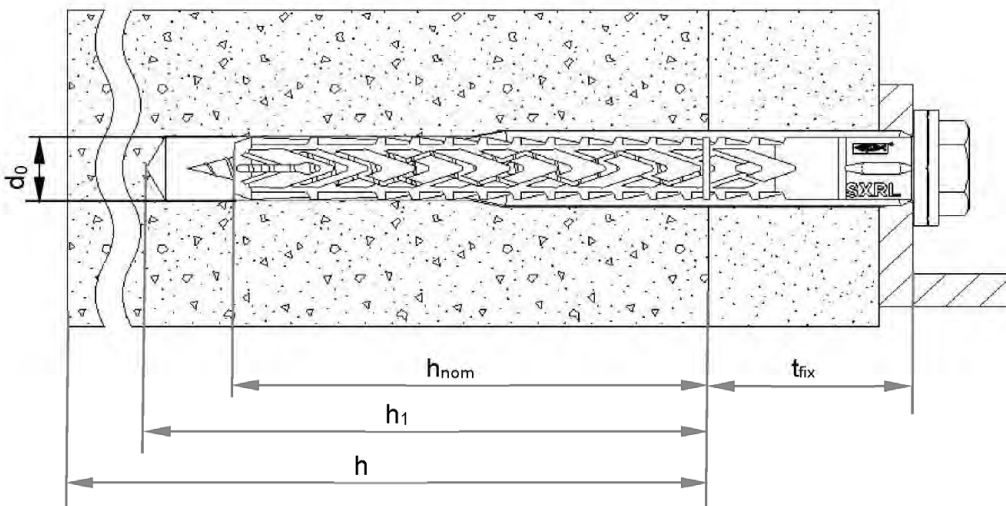

Legend

- h_{nom} = Overall plastic anchor embedment depth in the base material
- h_1 = Depth of drill hole to deepest point
- d_0 = Nominal drill hole diameter
- h = Thickness of member (base material)
- t_{fix} = Thickness of fixture and / or non-load-bearing layer

Figures not to scale

fischer frame fixing SXR / SXRL

Product description
Installed anchor

Annex A 1

Appendix 3 / 57

Anchor sleeves – flat collar versions of SXR and SXRL

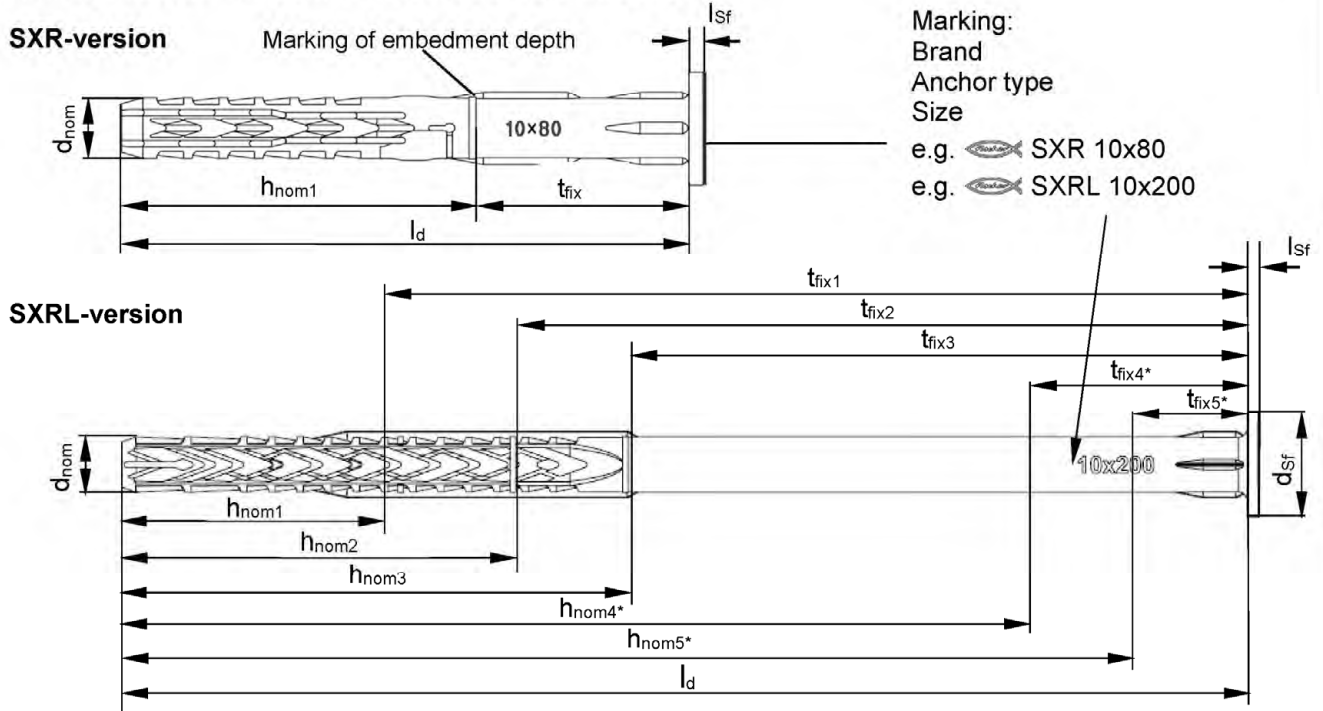

Countersunk sleeve version also available for both versions

*see Table A3.1 and Annex B 7

Special Screws

Countersunk screw

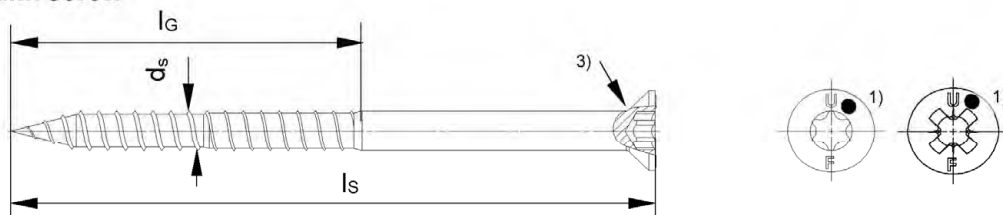

Hexagonal screw with washer

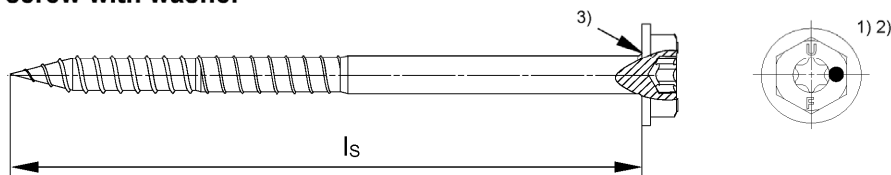

Hexagonal screw

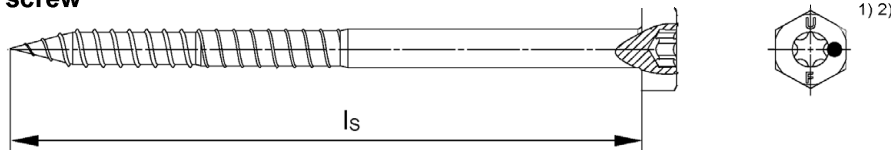

- 1) Additional marking for the special screw, stainless steel version: e.g. "A4" or "R" or "A2".
- 2) Internal driving feature for TX bit is optional for hexagonal head screw.
- 3) Optional additional version with underhead ribs.

Figures not to scale

fischer frame fixing SXR / SXRL

Product description
 Anchor types / special screws

Annex A 2

Appendix 4 / 57

Table A3.1: Dimensions

Anchor type	Anchor sleeve											Special screw		
	h_{nom1} [mm]	h_{nom2} [mm]	h_{nom3} [mm]	h_{nom4} [mm]	h_{nom5} [mm]	d_{nom} [mm]	t_{fix} [mm]	min. l_d [mm]	max. l_d [mm]	$l_{sf}^{1)}$ [mm]	$d_{sf}^{1)}$ [mm]	d_s [mm]	l_G [mm]	l_s [mm]
SXR 8	50	-	-	-	-	8	≥ 1	51	360	1,8	15,0	6	≥ 59	$l_d + l_{sf}^{1)} + d_s$
SXRL 8	50	70	90	-	-	8	≥ 1	51	360	1,8	15,0	6	≥ 59	$l_d + l_{sf}^{1)} + d_s$
SXR 10	50	-	-	-	-	10	≥ 1	51	360	2,2	18,5	7	≥ 57	$l_d + l_{sf}^{1)} + d_s$
SXRL 10	50 ²⁾	70	90 ³⁾⁴⁾	150 ⁴⁾	180 ⁴⁾	10	≥ 1	51	360	2,2	18,5	7	≥ 57	$l_d + l_{sf}^{1)} + d_s$
SXRL 14	-	70	90	-	-	14	≥ 1	71	600	3,1	24,0	10	≥ 63	$l_d + l_{sf}^{1)} + d_s$

1) Only valid for flat collar version.

2) Marking optional.

3) Additional h_{nom} for base material perforated clay brick S9 (see Annex C 32 and C 43) and autoclaved aerated concrete (see Annex C 44 and C 45).

4) Additional h_{nom} for base material perforated clay brick S8 (see Annex C 32 and C 43).

Table A3.2: Materials

Name	Material
Anchor sleeve	- Polyamide, PA6, colour grey
Special screw	- Galvanised steel gvz with Zn5/Ag or Zn5/An in accordance with EN ISO 4042 <u>or</u> - Galvanised steel gvz with Zn5/Ag or Zn5/An in accordance with EN ISO 4042 with additional organic layer (Zn5/Ag/T7 or Zn5/An/T7, respectively) in three layers (total layer thickness ≥ 6 µm) <u>or</u> - Stainless steel "A2" of corrosion resistance class CRC II in accordance with EN 1993-1-4 <u>or</u> - Stainless steel "A4" or "R" of corrosion resistance class CRC III in accordance with EN 1993-1-4

fischer frame fixing SXR / SXRL
Product description
 Dimensions and materials

Annex A 3

Appendix 5 / 57

Specifications of intended use

Anchorage subject to:

- Static and quasi-static loads.
- Redundant non-structural systems.

Base materials:

- Reinforced or unreinforced concrete without fibres, strength classes \geq C12/15 (base material group "a"), as per EN 206, see Annex C 1 and C 3.
- Thin-walled concrete components (e.g. weather shells) strength classes \geq C12/15 (base material group "a"), as per EN 206, thickness \geq 40 mm, see Annex C 1 and C 3.
- Pre-stressed compacted normal weight concrete core slabs \geq C45/55 (base material group "a") as per EN 206, see Annex C 1 and C 3.
- Solid brick masonry (base material group "b") as per EN 771-1, EN 771-2 or EN 771-3, see Annex C 3 – C 4, C 17 – C 26.

Note: The characteristic resistance is also valid for larger brick sizes and higher compressive strength of the masonry unit – all characteristic resistance values of solid brick masonry are valid for installation in the stretcher and in the header side of the bricks.

- Hollow or perforated brick masonry (base material group "c"), as per EN 771-1, EN 771-2 or EN 771-3, see Annex C 5 – C 15, C 26 – C 43: installation in stretcher side see Annex C 8, C 43: installation in header side.
- Reinforced autoclaved aerated concrete (base material group "d"), as per EN 12602, and unreinforced autoclaved aerated concrete (base material group "d") as per EN 771-4, see Annex C 15, C 44 and C 45.
- Mortar strength class of the masonry \geq M2,5 in accordance with EN 998-2.
- For other comparable base materials of the base material group "a", "b", "c" and "d" the characteristic resistance of the anchor may be determined by job site tests in accordance with TR 051.

Temperature Range:

SXR 8 and 10 and SXRL 8

- c: - 40 °C to 50 °C (max. short term temperature + 50 °C and max long term temperature + 30 °C)
- b: - 40 °C to 80 °C (max. short term temperature + 80 °C and max long term temperature + 50 °C)

SXRL 10 and 14

- c: - 20 °C to 50 °C (max. short term temperature + 50 °C and max long term temperature + 30 °C)
- b: - 20 °C to 80 °C (max. short term temperature + 80 °C and max long term temperature + 50 °C)

fischer frame fixing SXR / SXRL

Intended use
Specifications

Annex B 1

Appendix 6 / 57

Use conditions (Environmental conditions):

- Structures subject to dry internal conditions: Special screw made of zinc coated steel or stainless steel.
- The specific screw made of galvanised steel or galvanised steel with an additional organic layer may also be used in structures subject to external atmospheric exposure, if the area of the head of the screw is protected against moisture and driving rain after mounting of the fixing unit in this way, that intrusion of moisture into the anchor shaft is prevented. Therefore there shall be an external cladding or a ventilated rainscreen mounted in front of the head of the screw and the head of the screw itself shall be coated with a soft plastic, permanently elastic bitumen-oil-combination coating (e.g. undercoating or body cavity protection for cars).
- Structures subject to external atmospheric exposure (including industrial and marine environment) and to permanently damp internal condition, if no particular aggressive conditions exist: Special screw made of stainless steel of corrosion resistance class CRC III.

Note: Particular aggressive conditions are e.g. permanent, alternating immersion in seawater or the splash zone of seawater, chloride atmosphere of indoor swimming pools or atmosphere with extreme chemical pollution (e.g. in desulphurization plants or road tunnels where de-icing materials are used).

Design:

- The anchorages are to be designed in accordance with TR 064 under the responsibility of an engineer experienced in anchorages and concrete/masonry work.
- Verifiable calculation notes and drawings shall be prepared taking account of the loads to be anchored, the nature and strength of the base materials and the dimensions of the anchorage members as well as of the relevant tolerances. The position of the anchor is indicated on the design drawings.

Installation:

- Hole drilling by the drilling method in accordance with Annex C 1 for base material group “a” and Annex C 17 - C 45 for base material group “b”, “c” and “d”.
- Anchor installation carried out by appropriately qualified personnel and under the supervision of the person responsible for technical matters of the site.
- Installation temperature from SXR 8/10, SXRL 8 and SXRL 14: - 5 °C to + 40 °C
SXRL 10: - 20 °C to + 40 °C
- Exposure to UV due to solar radiation of the not protected anchor by rendering ≤ 6 weeks.
- No ingress of water in the borehole at temperatures < 0 °C.

fischer frame fixing SXR / SXRL

Intended use
Specifications

Annex B 2

Appendix 7 / 57

Table B3.1: Installation parameters

Anchor type			SXR 8	SXRL 8	SXR 10	SXRL 10	SXRL 14
Drill hole diameter	d_0	= [mm]	8	8	10	10	14
Cutting diameter of drill bit	d_{cut}	≤ [mm]	8,45	8,45	10,45	10,45	14,45
Overall plastic anchor embedment depth in the base material ¹⁾²⁾	h_{nom1}	≥ [mm]	50	50	50	50	-
	h_{nom2}	≥ [mm]	-	70	-	70	70
	$h_{nom3}^{3)4)}$	≥ [mm]	-	90	-	90	90
	$h_{nom4}^{4)}$	≥ [mm]	-	-	-	150	-
	$h_{nom5}^{4)}$	≥ [mm]	-	-	-	180	-
Depth of drill hole to deepest point ¹⁾	$h_{1,1}$	≥ [mm]	60	60	60	60	-
	$h_{1,2}$	≥ [mm]	-	80	-	80	85
	$h_{1,3}^{3)4)}$	≥ [mm]	-	100	-	100	105
	$h_{1,4}^{4)}$	≥ [mm]	-	-	-	160	-
	$h_{1,5}^{4)}$	≥ [mm]	-	-	-	190	-
Diameter of clearance hole in the fixture	d_f	≤ [mm]	8,50	9,50	10,50/12,50 ⁵⁾	10,50/12,50 ⁵⁾	15,40

1) See Annex A 1.

2) For base material group "c": If the embedment depth is higher than h_{nom} given in the Table B3.1, job site tests have to be carried out in accordance with TR 051.

3) Only valid for base material perforated clay brick S9 (see Annex C 32 and C 43) and autoclaved aerated concrete (see Annex C 44 and C 45).

4) Only valid for base material perforated clay brick S8 (see Annex C 32 and C 43).

5) See Table C2.1.

Table B3.2: Assignment of h_{nom} , l_d and t_{fix} for use in thin concrete slabs (e.g. weather resistant shells of external wall panels) and pre-stressed concrete core slabs

Anchor type		SXR 10 / SXRL 10			
Base material group "a" 	l_d [mm]		$h_{nom} \geq 50$ mm		
	SXR	SXRL	$t_{fix, min}$	$t_{fix, max}$	
	52	-	1	2	
	60	60	1	10	
	80	80	21	30	
	100	100	41	50	
	120	120	61	70	
	140	140	81	90	
	160	160	101	110	
	180	180	121	130	
	200	200	141	150	
	230	230	171	180	
	260	260	201	210	
	-	290	231	240	

Table B3.3: Installation parameters for use in pre-stressed hollow concrete core slabs

Anchor type		SXRL 10	
	Mirror thickness	$d_b \geq$ [mm]	30
	Overall plastic anchor embedment depth in the base material	h_{nom}	[mm] 50 to 59

fischer frame fixing SXR / SXRL
Intended use

Installation parameters, parameters for use in thin skins (e.g. weather resistant concrete skins of external wall panels) and pre-stressed hollow concrete core slabs

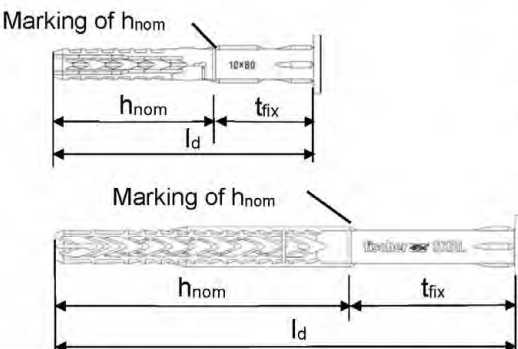
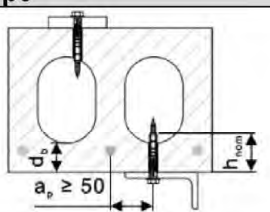
Annex B 3

Appendix 8 / 57

Table B4.1: Minimum thickness of member, edge distances and spacing in concrete – base material group “a”

Anchor type	Embedment depth h_{nom} [mm]	Concrete strength class	Minimum thickness of member h_{min} [mm]	Characteristic edge distance c_{cr} [mm]	Characteristic spacing s_{cr} [mm]	Minimum edge distances and spacing ¹⁾
						c_{min}, s_{min} [mm]
SXR 8	≥ 50	C12/15	100	70	70	$s_{min} = 70$ for $c \geq 70$ $c_{min} = 70$ for $s \geq 70$
		≥ C16/20		50	65	$s_{min} = 50$ for $c \geq 50$ $c_{min} = 50$ for $s \geq 50$
SXRL 8	≥ 50	C12/15	80	85	90	$s_{min} = 85$ for $c \geq 85$ $c_{min} = 85$ for $s \geq 85$
		≥ C16/20		60	75	$s_{min} = 60$ for $c \geq 60$ $c_{min} = 60$ for $s \geq 60$
	≥ 70	C12/15	100	85	105	$s_{min} = 85$ for $c \geq 85$ $c_{min} = 85$ for $s \geq 85$
		≥ C16/20		60	90	$s_{min} = 60$ for $c \geq 60$ $c_{min} = 60$ for $s \geq 60$
SXR 10	≥ 50	C12/15	100 ⁴⁾	140	100	$s_{min} = 70$ for $c \geq 210$ $c_{min} = 85$ for $s \geq 100$
		≥ C16/20		100	90	$s_{min} = 50$ for $c \geq 150$ $c_{min} = 60$ for $s \geq 70$
SXRL 10	≥ 50	≥ C12/15	100 ⁴⁾	140	120	$s_{min} = 70$ for $c \geq 140$ $c_{min} = 70$ for $s \geq 175$
		C16/20		100	105	$s_{min} = 50$ for $c \geq 100$ $c_{min} = 50$ for $s \geq 125$
	≥ 70 ²⁾	C12/15		140	120	$s_{min} = 70$ for $c \geq 140$ $c_{min} = 70$ for $s \geq 175$
		≥ C16/20		100	105	$s_{min} = 50$ for $c \geq 100$ $c_{min} = 50$ for $s \geq 125$
SXRL 14	≥ 70 ³⁾	C12/15	110	140	135	$s_{min} = 85$ for $c \geq 140$ $c_{min} = 85$ for $s \geq 175$
		≥ C16/20		100	120	$s_{min} = 60$ for $c \geq 100$ $c_{min} = 60$ for $s \geq 125$

1) Intermediate values by linear interpolation.

2) Values valid for reinforced concrete.

Please note: Values for non-reinforced concrete are $h_{min} = 110$ mm and $c_{min} = s_{min} = 80$ mm for concrete ≥ C16/20 and $c_{min} = s_{min} = 110$ mm for concrete C12/15.

3) Please note: Values for non-reinforced concrete are $h_{min} = 110$ mm, $c_{min} = 100$ mm, $s_{min} = 80$ mm for concrete ≥ C16/20 and $c_{min} = 140$ mm, $s_{min} = 110$ mm for concrete C12/15.

4) Also valid for thin concrete slabs and prestressed hollow concrete core slabs see Table B3.3 $h \geq 40$ mm, $h_{nom} = 50$ mm to 59 mm.

Fixing points with a spacing $a \leq s_{cr}$ are considered as a group with a maximum characteristic resistance $N_{RK,p}$ according to Table C1.2. For a spacing $a > s_{cr}$ the anchors are considered as single anchors, each with a characteristic resistance $N_{RK,p}$ according to Table C1.2.

Scheme of edge distances and spacing in concrete base material group “a”

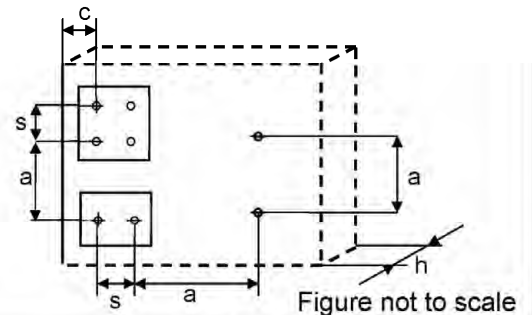

Figure not to scale

fischer frame fixing SXR / SXRL

Intended use

Minimum thickness of member, edge distances and spacing for use in concrete

Annex B 4

Appendix 9 / 57

Table B5.1: Minimum thickness of member, edge distances and spacing in solid and hollow or perforated masonry – base material group “b” and “c”

Anchor type		SXR 8	SXRL 8	SXR 10	SXRL 10	SXRL 14
Minimum thickness of member ¹⁾	h_{min} [mm]	100	115	100	110	115
Distance between anchor groups and / or single anchors	a_{min} [mm]	250	250	250	250	250
Single anchor						
Minimum edge distance ²⁾	c_{min} [mm]	100	100	100	100	100
Anchor group						
Minimum spacing perpendicular to free edge ²⁾	$s_{1,min}$ [mm]	100 ³⁾	100 ³⁾	100 ³⁾	100 ³⁾	100 ³⁾
Minimum spacing parallel to free edge ²⁾	$s_{2,min}$ [mm]	100 ³⁾	100 ³⁾	100 ³⁾	100 ³⁾	100 ³⁾
Minimum edge distance ²⁾	c_{min} [mm]	100	100	100	100	100

1) Thickness of member see Annex C 3 – C 43.

2) For use in the header side for "Schlagmann Poroton S9" and "Schlagmann S8 Halbstein LZ" see Annex C 43.

3) For some anchor sizes and bricks Footnotes ⁷⁾ and ⁸⁾ on Annex C 16 have to be considered

Scheme of edge distances and spacing

in solid and hollow or perforated brick masonry
base material group “b” and “c” and reinforced
and unreinforced autoclaved aerated concrete
base material group “d”

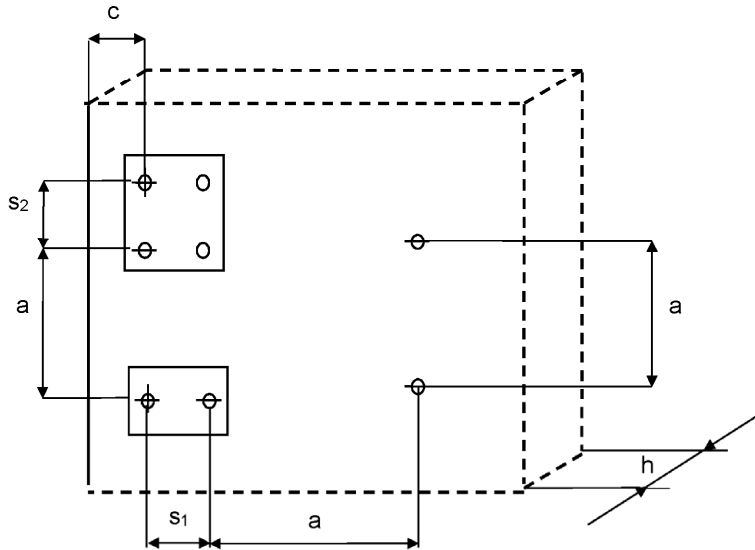

Figure not to scale

fischer frame fixing SXR / SXRL

Intended use

Minimum thickness of member, edge distances and spacing for use in solid and hollow or perforated masonry

Annex B 5

Appendix 10 / 57

Table B6.1: Minimum thickness of member, edge distances and spacing in unreinforced autoclaved aerated concrete - base material group "d"

Anchor type		SXRL 8		SXR 10	SXRL 10		SXRL 14		
Compressive strength	$f_{cm,decl}$ [N/mm ²]	≥ 2 to < 6	≥ 6	≥ 2	≥ 2		≥ 2 to < 4		≥ 4
Nominal embedment depth	$h_{nom} ≥$ [mm]	70 and 90		50	70	90	70	90	70 90
Minimum thickness of member ¹⁾	h_{min} [mm]	175		100	100	120	175		300
Minimum distance between anchor groups and / or single anchors	a_{min} [mm]	250		400	250		250		
Single anchor									
Minimum edge distance	c_{min} [mm]	60	80	100	120		80	100	120
Anchor group									
Minimum spacing perpendicular to free edge	$s_{1,min}$ [mm]	80	110	200	100 / 120 ²⁾		80	80	100
Minimum spacing parallel to free edge	$s_{2,min}$ [mm]	80	110	400	100 / 120 ²⁾		80	100	80 125
Minimum edge distance	c_{min} [mm]	90	110	100	120		120		150

¹⁾ See Table C44.1.

²⁾ Only valid for bulk density $\rho ≥ 600$ kg/m³.

Table B6.2: Minimum thickness of member, edge distances and spacing in reinforced autoclaved aerated concrete - base material group "d"

Anchor type [size x h_{nom}]		SXRL 10 x 70		SXRL 10 x 90	
Compressive strength ¹⁾	f_{ck} [N/mm ²]	≥ 2	≥ 6	≥ 2	≥ 6
Minimum spacing between anchor groups and / or single anchors	a_{min} [mm]	250	250	250	250
Single anchor					
Minimum thickness of member	h_{min} [mm]	100	240	120	240
Minimum edge distance	$c_{1,min}$ [mm]	120	120	120	120
Minimum edge distance perpendicular to $c_{1,min}$	$c_{2,min}$ [mm]	180	180	180	180
Anchor group					
Minimum thickness of member	h_{min} [mm]	175	240	175	240
Minimum edge distance	$c_{1,min}$ [mm]	100	120	100	120
Minimum edge distance perpendicular to $c_{1,min}$	$c_{2,min}$ [mm]	150	180	150	180
Minimum spacing perpendicular to free edge	$s_{1,min}$ [mm]	100	120	100	120
Minimum spacing parallel to free edge	$s_{2,min}$ [mm]	100	120	100	120

¹⁾ See Table C45.1.

Scheme of edge distances and spacing see Annex B 5

fischer frame fixing SXR / SXRL

Intended use

Minimum thickness of member, edge distances and spacing for use in unreinforced and in reinforced autoclaved aerated concrete

Annex B 6

Appendix 11 / 57

Installation instructions

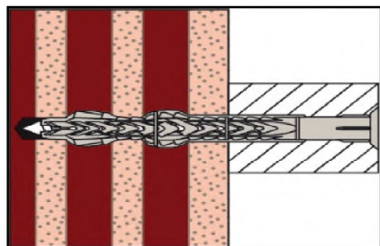
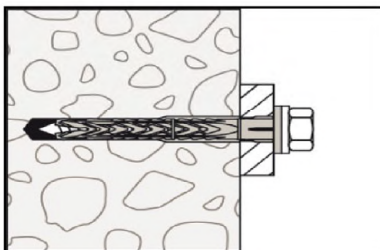
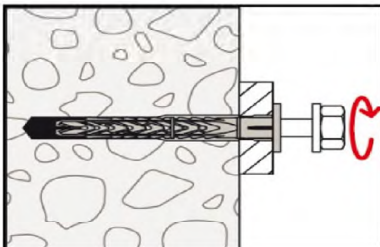
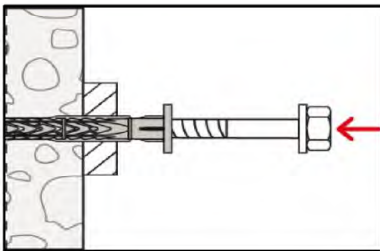
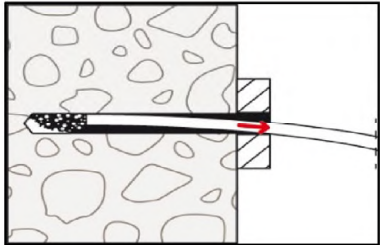
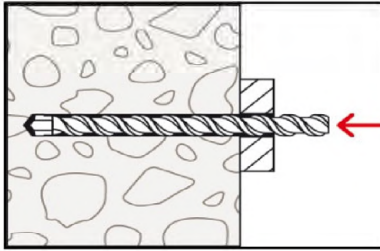

1. Drill the bore hole according to Table B3.1 using the drilling method described in the corresponding Annex C.

2. Base material group „a“, „b“, „d“: Remove dust from borehole.

3. Insert anchor (screw and sleeve) by using a hammer until the collar of the plastic sleeve is flush with the surface of the fixture. In case of using brick S8 (see Table A3.1 footnote 4), additional embedment depths h_{nom} 150mm or h_{nom} 180 mm may be taken by measuring the anchorage depth and the fixture height. The corresponding length of anchor should be taken.

4. The screw is screwed-in until the head of the screw touches the sleeve. The anchor is correctly mounted, when the head of the screw fits tight on the surface and cannot be screwed-in any further.

5. Correctly installed anchor in concrete.

6. Correctly installed anchor in hollow or perforated masonry.

fischer frame fixing SXR / SXRL

Intended use
Installation instructions

Annex B 7

Appendix 12 / 57

Table C1.1: Characteristic resistance of the screw

Failure of expansion element (special screw)		SXR 8 / SXRL 8		SXR 10 / SXRL 10		SXRL 14	
		galvanised steel	stainless steel	galvanised steel	stainless steel	galvanised steel	stainless steel
Characteristic tension resistance	$N_{Rk,s}$ [kN]	14,8	14,3	21,7 24,9 ²⁾	21,7	43,4	42,0
Partial factor	γ_{Ms} ¹⁾ [-]	1,50	1,55	1,55	1,55	1,50	1,55
Characteristic shear resistance	$V_{Rk,s}$ [kN]	7,4	7,1	10,8 12,4 ²⁾	10,8	21,7	21,0
Partial factor	γ_{Ms} ¹⁾ [-]	1,25	1,29	1,29	1,29	1,25	1,29

Characteristic bending resistance of the screw

Overall plastic anchor embedment depth in the base material [mm]						h_{nom2} 70	h_{nom3} 90	h_{nom2} 70	h_{nom3} 90
Characteristic bending resistance	$M_{Rk,s}$ [Nm]	12,4	12,0	20,6 23,6 ²⁾	20,6	48,7	62,5	47,0	60,5
Partial factor	γ_{Ms} ¹⁾ [-]	1,25	1,29	1,29	1,29	1,25	1,29	1,29	1,29

¹⁾ In absence of other national regulations.

²⁾ Only for SXRL 10: "High load" screw version on request only for countersunk screws – head marking is ●●

Table C1.2: Characteristic resistance due to pullout-failure for use in concrete - base material group "a"¹⁾

Pull-out failure (plastic sleeve)		SXR 8	SXRL 8	SXR 10	SXRL 10	SXRL 14
Embedment depth h_{nom} [mm]	\geq	50	50	70	50	70

Concrete \geq C12/15

Characteristic tension resistance 30/50 °C	$N_{Rk,p}$ [kN]	3,0	4,0	5,0	5,0	5,5	8,0	8,5
Characteristic tension resistance 50/80 °C	$N_{Rk,p}$ [kN]	2,5 3,0 ³⁾	4,0	5,0	4,5	5,0	6,5	8,5

Concrete \geq C12/15 (e.g. weather resistant shells of external wall panels)

Characteristic tension resistance 30/50 °C	$N_{Rk,p}$ [kN]	$h \geq 40$ mm	5)	5)	5)	3,5	2,5 3,0 ³⁾	5)	5)
Characteristic tension resistance 50/80 °C	$N_{Rk,p}$ [kN]	$h \geq 40$ mm	5)	5)	5)	3,0	2,5 3,0 ³⁾	5)	5)

Concrete \geq C45/55 in pre-stressed concrete core slabs

Characteristic resistance 50/80 °C	$N_{Rk,p}$ [kN]	$d_b \geq 30$ mm	5)	5)	5)	5)	3,5 4,0 ⁴⁾	5)	5)
		$d_b \geq 40$ mm	5)	5)	5)	5)	5,5 6,0 ⁴⁾	5)	5)
Partial factor	γ_{Mc} ²⁾ [-]	1,8							

¹⁾ Drilling method: Hammer drilling.

²⁾ In absence of other national regulations.

³⁾ Only valid in concrete \geq C16/20.

⁴⁾ Only valid for temperature range 30/50 °C.

⁵⁾ No performance assessed.

fischer frame fixing SXR / SXRL**Performances**

Characteristic resistance and characteristic bending resistance of the screw
Characteristic resistance for use in concrete

Annex C 1

Appendix 13 / 57

Table C2.1: Displacements¹⁾ under tension and shear loading in concrete and masonry

Displacements under			Tension load ²⁾		Shear load ²⁾	
Anchor type	h_{nom} [mm]	F [kN]	δ_{No} [mm]	$\delta_{N\infty}$ [mm]	δ_{Vo} [mm]	$\delta_{V\infty}$ [mm]
SXR 8	50	1,2	0,65	1,30	1,02	1,53
SXRL 8	50	1,6	0,56	1,12	2,00	3,00
	70	2,0	0,64	1,28	2,30	3,45
SXR 10	50	2,0	1,29	2,58	1,15 ^{3)/3,05⁴⁾}	1,74 ^{3)/4,58⁴⁾}
SXRL 10	50	2,2	0,58	1,16	1,96	2,94
	70	3,2	1,74	3,48	1,69 ^{3)/3,13⁴⁾}	2,54 ^{3)/4,69⁴⁾}
	90	3,2	1,74	3,48	1,69 ^{3)/3,13⁴⁾}	2,54 ^{3)/4,69⁴⁾}
SXRL 14	70	3,4	0,39	0,63	2,79	4,19
	90	3,4	0,39	0,63	2,79	4,19

¹⁾ Valid for all ranges of temperatures.

²⁾ Intermediate values by linear interpolation.

³⁾ Valid for diameter in the clearance hole $\leq 10,5$ mm (see Table B3.1).

⁴⁾ Valid for diameter in the clearance hole = 12,5 mm (see Table B3.1).

Table C2.2: Displacements¹⁾ under tension and shear loading in autoclaved aerated concrete

Displacements under				Tension load ²⁾		Shear load ²⁾		
Anchor type	Base material type	$f_{ck} / f_{cm,decl}$ [N/mm ²]	h_{nom} [mm]	F [kN]	δ_{No} [mm]	$\delta_{N\infty}$ [mm]	δ_{Vo} [mm]	$\delta_{V\infty}$ [mm]
SXRL 8	unreinforced autoclaved aerated concrete	≥ 2	70/90	0,14/0,21	0,45/0,55	0,90/1,10	0,28/0,42	0,42/0,63
		≥ 6	70/90	1,07	0,73/0,80	1,46/1,60	2,14	3,21
SXR 10		≥ 2	50	0,32	0,03	0,06	0,21	0,31
SXRL 10		≥ 2	70/90	0,32	0,23	0,46	0,64	0,96
		≥ 6	70/90	1,43	0,65	1,30	2,86	4,29
SXRL 14		≥ 2	70/90	0,32/0,43	0,19/0,25	0,38/0,50	0,64/0,86	0,96/1,29
		≥ 3	70/90	0,60/0,77	0,23/0,31	0,45/0,63	1,19/1,54	1,79/2,31
		≥ 4	70/90	0,88/1,11	0,26/0,38	0,53/0,76	1,75/2,22	2,62/3,33
		≥ 6	70/90	1,43/1,79	0,34/0,51	0,68/1,02	2,86/3,58	4,29/5,37
SXRL 10		reinforced autoclaved aerated concrete	≥ 2	70/90	0,18	0,14/0,33	0,28/0,66	0,36
	≥ 6		70/90	1,07/1,25	0,49/0,73	0,98/1,46	2,14/2,50	3,21/3,75

¹⁾ Valid for all ranges of temperatures.

²⁾ Intermediate values by linear interpolation.

Table C2.3: Values under fire exposure in concrete C20/25 to C50/60 in any load direction (no permanent centric tension load, shear load without lever arm) fastening of façade systems

Anchor type	Fire resistance class	$F_{Rk,fi,90}$	$\gamma_{M,fi}$ ¹⁾
SXR 10 / SXRL 10 / SXRL 14	R 90	0,8 kN	1,0

¹⁾ In absence of other national regulations.

If one-side fire load, see table B4.1 for edge distance.

In case of fire attack from more than one side the minimum edge distance shall be $c \geq 300$ mm, $c \geq 2 \cdot h_{ef}$; the bigger value is decisive.

fischer frame fixing SXR / SXRL

Performances

Displacements under tension and shear loading in concrete, masonry and autoclaved aerated concrete, fire resistance in concrete

Annex C 2

Appendix 14 / 57

Table C3.1: Summary of concrete – base material group “a” and solid bricks – base material group “b”⁽¹⁾

Base material	Format	Dimensions (L x W x H) [mm]	Mean compressive strength as per EN 771 [N/mm ²]	Bulk density ρ [kg/dm ³]	See Annex
Concrete \geq C12/15 as per EN 206					C 1
Weather resistant shells of external wall panels \geq C12/15 as per EN 206					C 1
Pre-stressed concrete core slabs \geq C45/55 as per EN 206					C 1
Clay brick Mz , as per EN 771-1, e.g. <i>Schlagmann, DE</i>	3 DF	240 x 175 x 113	≥ 10	$\geq 1,8$	C 17
Clay brick Mz , as per EN 771-1, e.g. <i>Wienerberger, DK</i>	DF	240 x 115 x 52	≥ 10	$\geq 1,8$	C 17
Clay brick Mz , as per EN 771-1, e.g. <i>Schlagmann, DE</i> e.g. <i>Ebersdobler, DE</i>	NF	240 x 115 x 71	≥ 10	$\geq 1,8$	C 18
Clay brick Mz , as per EN 771-1, e.g. <i>Schlagmann, DE</i>	2 DF	240 x 115 x 113	≥ 10	$\geq 2,4$	C 19
Calcium silicate solid brick KS , as per EN 771-2, e.g. <i>KS Wemding, DE</i>	NF	240 x 115 x 71	≥ 10	$\geq 1,8$	C 19 C 20
Calcium silicate solid brick KS , as per EN 771-2, e.g. <i>Bayer Esslingen, DE</i>	2 DF	240 x 115 x 113	≥ 10	$\geq 2,0$	C 20
Calcium silicate solid brick KS , as per EN 771-2, e.g. <i>KS Wemding, DE</i>	12 DF	495 x 175 x 240	≥ 10	$\geq 1,8$	C 21
Calcium silicate solid brick KS , as per EN 771-2, e.g. <i>KS Wemding, DE</i>	8 DF	495 x 115 x 240	≥ 10	$\geq 2,0$	C 22
Calcium silicate solid brick KS XL-PE , as per EN 771-2, e.g. <i>KS Wemding, DE</i>	XL-PE	998 x 150 x 498	≥ 10	$\geq 2,0$	C 22

¹⁾ Vertically perforation $\leq 15\%$; cross section reduced by perforation vertically to the resting area.

fischer frame fixing SXR / SXRL

Performances

Summary of base materials concrete and solid bricks

Annex C 3

Appendix 15 / 57

Table C4.1: Summary of solid bricks – base material group “b”⁽¹⁾

Base material	Format	Dimensions (L x W x H) [mm]	Mean compressive strength as per EN 771 [N/mm²]	Bulk density ρ [kg/dm³]	See Annex
Lightweight solid brick Vbl , as per EN 771-3, e.g. <i>KLB, DE</i>	2 DF	240 x 115 x 113	≥ 2,5	≥ 1,2	C 23
Lightweight solid brick Vbl , as per EN 771-3, e.g. <i>KLB, DE</i>	8 DF	490 x 115 x 240	≥ 2,5	≥ 1,0	C 23 C 24
Lightweight solid brick Vbl , as per EN 771-3, e.g. <i>KLB, DE</i>	8 DF	245 x 240 x 240	≥ 2,5	≥ 1,4	C 24
Lightweight solid brick Vbl , as per EN 771-3, e.g. <i>Liapor Super-K, DE</i>	16 DF	500 x 240 x 248	≥ 1,8	≥ 0,8	C 25
Lightweight solid brick concrete Vbl , as per EN 771-3, e.g. <i>Tarmac, UK</i>	-	440 x 100 x 210	≥ 2,5	≥ 1,4	C 25
Solid brick normal concrete Vbn , as per EN 771-3, e.g. <i>Adolf Blatt, DE</i>	-	240x245x240	≥ 5	≥ 1,8	C 25
Lightweight solid brick Vbn , as per EN 771-3, e.g. <i>Tarmac UK</i>	-	440 x 100 x 210	≥ 7,5	≥ 1,8	C 26

¹⁾ Vertically perforation ≤ 15%; cross section reduced by perforation vertically to the resting area.

fischer frame fixing SXR / SXRL

Performances

Summary of base materials solid bricks

Annex C 4

Appendix 16 / 57

Table C5.1: Summary of hollow or perforated bricks – base material group “c”¹⁾

Base material	Format/ Dimensions (L x W x H) [mm]	Brick drawing [mm]	Mean compressive strength as per EN 771 [N/mm ²] / bulk density ρ [kg/dm ³]	See Annex
<p>Perforated clay brick HLz Form B, as per EN 771-1, <i>e.g. Wienerberger, DE</i></p>	<p>2 DF 240 x 115 x 113</p>		<p>≥ 10 / ≥ 1,2</p>	<p>C 26</p>
<p>Perforated clay brick HLz as per EN 771-1, <i>e.g. Wienerberger, DE</i></p>	<p>2 DF 240 x 115 x 113</p>		<p>≥ 10 / ≥ 1,0</p>	<p>C 27</p>
<p>Perforated clay brick VHLz as per EN 771-1, <i>e.g. Wienerberger, DE</i></p>	<p>NF 240 x 115 x 71</p>		<p>≥ 20 / ≥ 1,6</p>	<p>C 28</p>
<p>Perforated clay brick VHLz as per EN 771-1, <i>e.g. Wienerberger, DE</i></p>	<p>2 DF 240 x 115 x 113</p>		<p>≥ 12,5 / ≥ 1,6</p>	<p>C 28</p>

¹⁾ Vertically perforation > 15 % and ≤ 50 %, cross section reduced by perforation vertically to the resting area.

Figures not to scale

fischer frame fixing SXR / SXRL

Performances
Summary of base materials hollow or perforated bricks

Annex C 5

Appendix 17 / 57

Table C6.1: Summary of hollow or perforated bricks – base material group “c”¹⁾

Base material	Format/ Dimensions (L x W x H)	Brick drawing [mm]	Mean compressive strength as per EN 771 [N/mm ²] / bulk density ρ [kg/dm ³]	See Annex
Perforated clay brick HLz as per EN 771 -1, e.g. Wienerberger, BS, DE	DF 240 x 110 x 52		$\geq 10 / \geq 1,5$	C 29
Perforated clay brick HLz as per EN 771-1, e.g. Schlagmann, DE	10 DF 440 x 260 x 240		$\geq 5 / \geq 0,9$	C 29
Perforated clay brick HLz as per EN 771-1, e.g. Schlagmann Poroton T14, DE	10 DF 240 x 300 x 240		$5 / \geq 0,7$	C 30
Perforated clay brick HLz as per EN 771-1, e.g. Schlagmann Planfüllziegel, DE	12 DF 380 x 240 x 240		$\geq 2,5 / \geq 0,7$	C 30

¹⁾ Vertically perforation > 15 % and ≤ 50 %, cross section reduced by perforation vertically to the resting area.
 Figures not to scale

Table C7.1: Summary of hollow or perforated bricks – base material group “c”⁽¹⁾

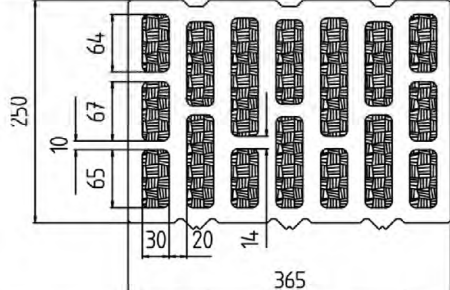
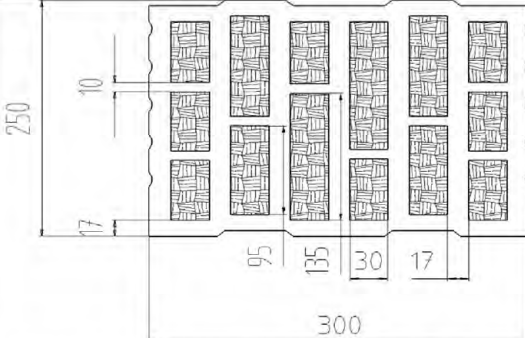
Base material	Format/ Dimensions (L x W x H) [mm]	Brick drawing [mm]	Mean compressive strength as per EN 771 [N/mm ²] / bulk density ρ [kg/dm ³]	See Annex
<p>Perforated clay brick HLz as per EN 771-1, e.g. <i>Schlagmann, DE</i></p>	<p>3 DF 240 x 175 x 113</p>		<p>≥ 7,5 / ≥ 1,0</p>	<p>C 30</p>
<p>Perforated clay brick HLz as per EN 771-1, e.g. <i>Schlagmann Poroton S11, DE</i></p>	<p>12 DF 250 x 365 x 240</p>		<p>≥ 5 / ≥ 0,8</p>	<p>C 31</p>
<p>Perforated clay brick HLz as per EN 771-1, e.g. <i>Schlagmann Poroton S10, DE</i></p>	<p>10 DF 250 x 300 x 240</p>		<p>≥ 5 / ≥ 0,7</p>	<p>C 31</p>

¹⁾ Vertically perforation > 15 % and ≤ 50 %, cross section reduced by perforation vertically to the resting area.

Figures not to scale

fischer frame fixing SXR / SXRL

Performances
Summary of base materials hollow or perforated bricks

Annex C 7

Appendix 19 / 57

Table C8.1: Summary of hollow or perforated bricks – base material group “c”¹⁾

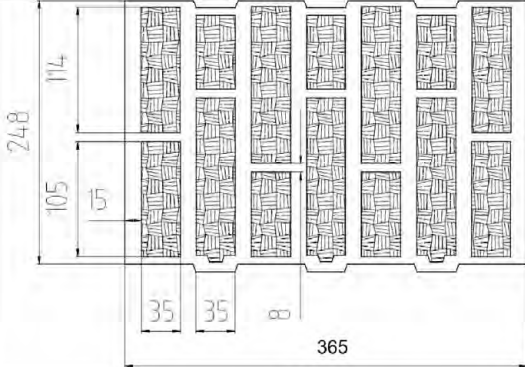
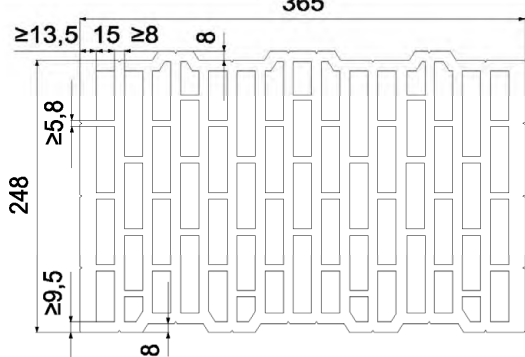
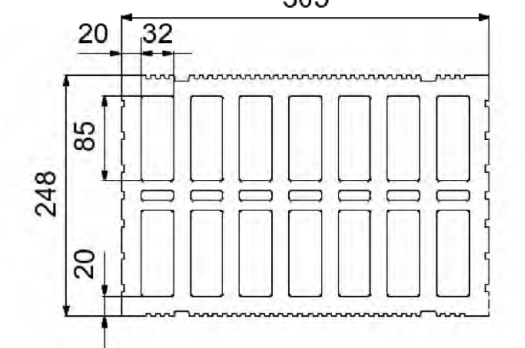
Base material	Format/ Dimensions (L x W x H) [mm]	Brick drawing [mm]	Mean compressive strength as per EN 771 [N/mm ²] / bulk density ρ [kg/dm ³]	See Annex
<p>Perforated clay brick HLz as per EN 771-1, e.g. <i>Schlagmann Poroton T8, DE</i></p>	<p>12 DF 248 x 365 x 249</p>		<p>$\geq 2,5 / \geq 0,6$</p>	<p>C 31</p>
<p>Perforated clay brick HLz as per EN 771-1, e.g. <i>Schlagmann, DE</i></p>	<p>248 x 365 x 249</p>		<p>$\geq 7,5 / \geq 0,75$</p>	<p>C 32 C 43 (header side)</p>
<p>Perforated clay brick HLz as per EN 771-1, e.g. <i>Schlagmann S8 Halbziegel LZ, DE</i></p>	<p>248/123 x 365 x 249</p>		<p>$\geq 5 / \geq 0,75$</p>	<p>C 32 C 43 (header side)</p>

¹⁾ Vertically perforation > 15 % and ≤ 50 %, cross section reduced by perforation vertically to the resting area.

Figures not to scale

fischer frame fixing SXR / SXRL

Performances

Summary of base materials hollow or perforated bricks

Annex C 8

Appendix 20 / 57

Table C9.1: Summary of hollow or perforated bricks – base material group “c”⁽¹⁾

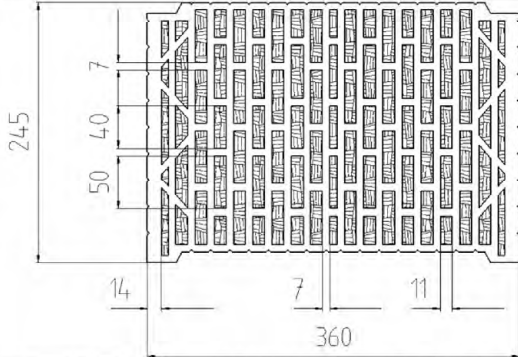
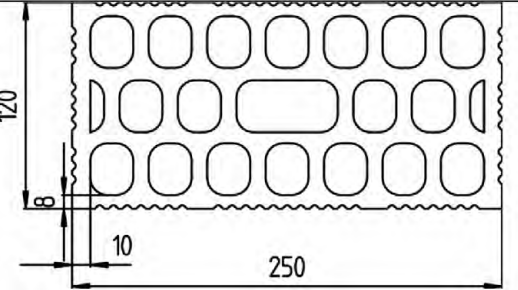
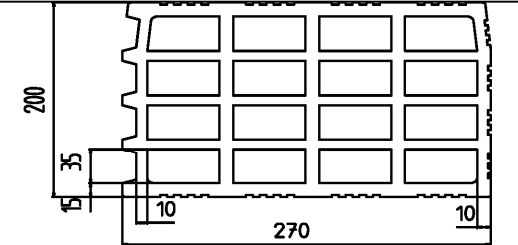
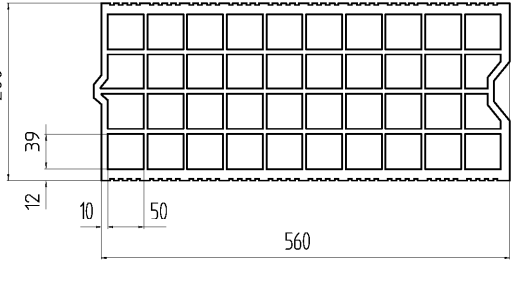
Base material	Format/ Dimensions (L x W x H) [mm]	Brick drawing [mm]	Mean compressive strength as per EN 771 [N/mm ²] / bulk density ρ [kg/dm ³]	See Annex
<p>Perforated clay brick HLz as per EN 771-1, e.g. <i>Hörl & Hartmann Coriso WS 09, DE</i></p>	<p>10 DF 245 x 365 x 249</p>		<p>≥ 2,5 / ≥ 0,8</p>	<p>C 33</p>
<p>Perforated clay brick HLz as per EN 771-1, e.g. <i>Doppio Uni IT Wienerberger, IT</i></p>	<p>250 x 120 x 190</p>		<p>≥ 7,5 / ≥ 0,9</p>	<p>C 33</p>
<p>Perforated clay brick HLz as per EN 771-1, e.g. <i>Imerys Gelimatic, FR</i></p>	<p>500 x 200 x 270</p>		<p>≥ 5 / ≥ 0,6</p>	<p>C 34</p>
<p>Perforated clay brick HLz as per EN 771-1, e.g. <i>Imerys Optibric, FR</i></p>	<p>560 x 200 x 275</p>		<p>≥ 5 / ≥ 0,6</p>	<p>C 34</p>

¹⁾ Vertically perforation > 15 % and ≤ 50 %, cross section reduced by perforation vertically to the resting area.

Figures not to scale

fischer frame fixing SXR / SXRL

Performances
Summary of base materials hollow or perforated bricks

Annex C 9

Appendix 21 / 57

Table C10.1: Summary of hollow or perforated bricks – base material group “c”⁽¹⁾

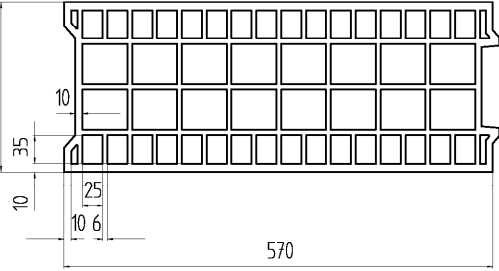
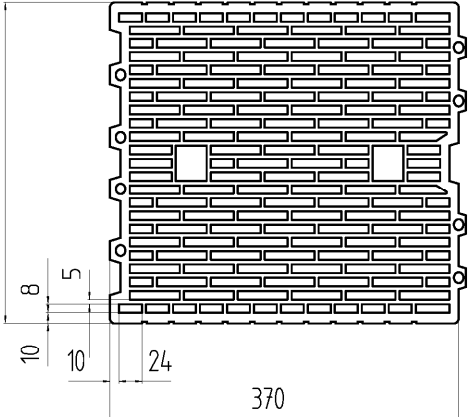
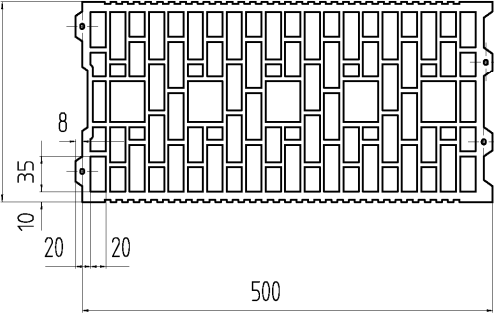
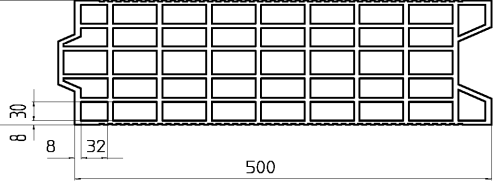
Base material	Format/ Dimensions (L x W x H) [mm]	Brick drawing [mm]	Mean compressive strength as per EN 771 [N/mm ²] / bulk density ρ [kg/dm ³]	See Annex
<p>Perforated clay brick HLz as per EN 771-1, e.g. Bouyer Leroux BGV, FR</p>	<p>570 x 200 x 315</p>		<p>≥ 5 / ≥ 0,6</p>	<p>C 34</p>
<p>Perforated clay brick HLz as per EN 771-1, e.g. Wienerberger Porotherm 30 R, FR</p>	<p>370 x 300 x 250</p>		<p>≥ 7,5 / ≥ 0,7</p>	<p>C 35</p>
<p>Perforated clay brick HLz as per EN 771-1, e.g. Wienerberger Porotherm GF R20, FR</p>	<p>500 x 200 x 275</p>		<p>≥ 5 / ≥ 0,7</p>	<p>C 35</p>
<p>Perforated clay brick HLz as per EN 771-1, e.g. Terreal Calibric, FR</p>	<p>500 x 200 x 220</p>		<p>≥ 5 / ≥ 0,7</p>	<p>C 36</p>

¹⁾ Vertically perforation > 15 % and ≤ 50 %, cross section reduced by perforation vertically to the resting area.

Figures not to scale

fischer frame fixing SXR / SXRL

Performances
Summary of base materials hollow or perforated bricks

Annex C 10

Appendix 22 / 57

Table C11.1: Summary of hollow or perforated bricks – base material group “c”¹⁾

Base material	Format/ Dimensions (L x W x H) [mm]	Brick drawing [mm]	Mean compressive strength as per EN 771 [N/mm ²] / bulk density ρ [kg/dm ³]	See Annex
<p>Perforated clay ceiling brick as per EN 15037-3 e.g. Hörl & Hartmann ceiling block, DE</p>	<p>250 x 250 x 190</p>		<p>≥ 5 / ≥ 0,7</p>	<p>C 36</p>
<p>Perforated clay ceiling brick as per EN 15037-3, e.g. Hörl & Hartmann block for beam-and-block ceilings, DE</p>	<p>520 x 180 x 250</p>		<p>≥ 2,5 / ≥ 0,7</p>	<p>C 36</p>
<p>Hollow calcium silicate brick KSL as per EN 771-2, e.g. KS Wemding, DE</p>	<p>2 DF 240 x 115 x 113</p>		<p>≥ 7,5 / ≥ 1,4</p>	<p>C 37</p>

¹⁾ Vertically perforation > 15 % and ≤ 50 %, cross section reduced by perforation vertically to the resting area.

Figures not to scale

fischer frame fixing SXR / SXRL

Performances
Summary of base materials hollow or perforated bricks

Annex C 11

Appendix 23 / 57

Table C12.1: Summary of hollow or perforated bricks – base material group “c”⁽¹⁾

Base material	Format/ Dimensions (L x W x H) [mm]	Brick drawing [mm]	Mean compressive strength as per EN 771 [N/mm ²] / bulk density ρ [kg/dm ³]	See Annex
Hollow calcium silicate brick KSL as per EN 771-2, e.g. <i>KS Wemding, DE</i>	3 DF 240 x 175 x 113		≥ 7,5 / ≥ 1,4	C 37
Hollow calcium silicate brick KSL as per EN 771-2, e.g. <i>KS Wemding, DE</i>	9 DF 375 x 175 x 248		≥ 10 / ≥ 1,6	C 38
Hollow calcium silicate brick KSL as per EN 771-2, e.g. <i>KS Wemding, DE</i>	5 DF 300 x 240 x 113		≥ 7,5 / ≥ 1,4	C 38

¹⁾ Vertically perforation > 15 % and ≤ 50 %, cross section reduced by perforation vertically to the resting area.

Figures not to scale

fischer frame fixing SXR / SXRL

Performances
 Summary of base materials hollow or perforated bricks

Annex C 12
 Appendix 24 / 57

Table C13.1: Summary of hollow or perforated bricks – base material group “c”⁽¹⁾

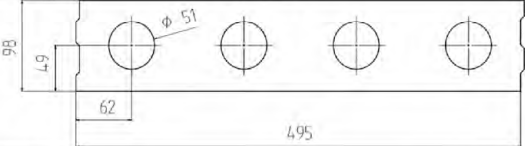
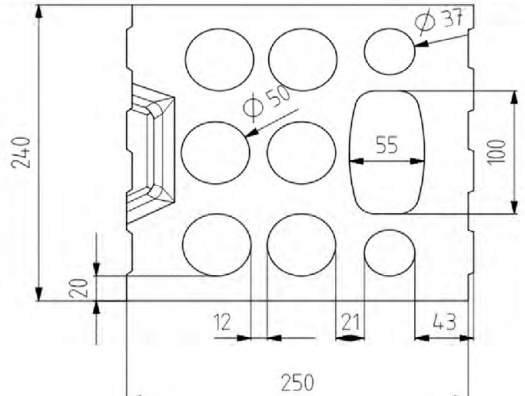
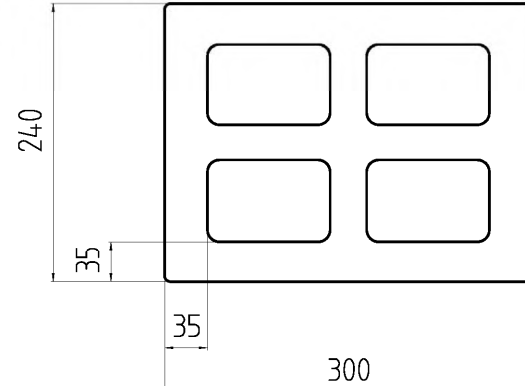
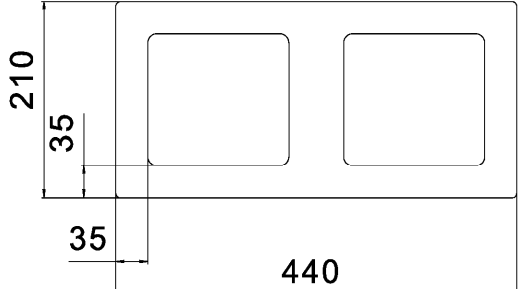
Base material	Format/ Dimensions (L x W x H) [mm]	Brick drawing [mm]	Mean compressive strength as per EN 771 [N/mm ²] / bulk density ρ [kg/dm ³]	See Annex
Hollow calcium silicate brick KSL as per EN 771-2, e.g. KS Wemding, P10, DE	495 x 98 x 245		≥ 2,5 / ≥ 1,2	C 39
Hollow calcium silicate brick KSL as per EN 771-2, e.g. KS Wemding, DE	9 DF 250 x 240 x 240		≥ 7,5 / ≥ 1,4	C 39
Hollow brick light-weight concrete Hbl as per EN 771-3, e.g. KLB, DE	300 x 240 x 240		≥ 2,5 / ≥ 1,4	C 39
Hollow brick light-weight concrete Hbl as per EN 771-3, e.g. Roadstone masonry, IE	440 x 210 x 215		≥ 2,5 / ≥ 1,2	C 40

¹⁾ Vertically perforation > 15 % and ≤ 50 %, cross section reduced by perforation vertically to the resting area.

Figures not to scale

fischer frame fixing SXR / SXRL

Performances

Summary of base materials hollow or perforated bricks

Annex C 13

Appendix 25 / 57

Table C14.1: Summary of hollow or perforated bricks – base material group “c”⁽¹⁾

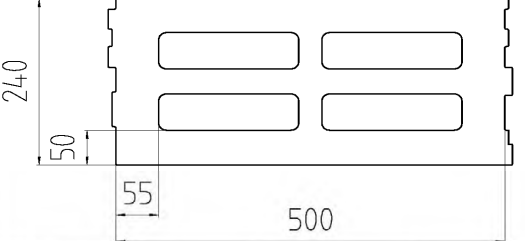
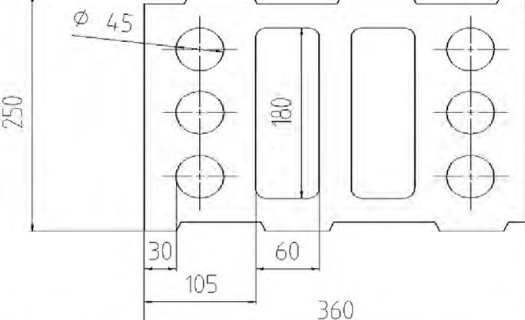
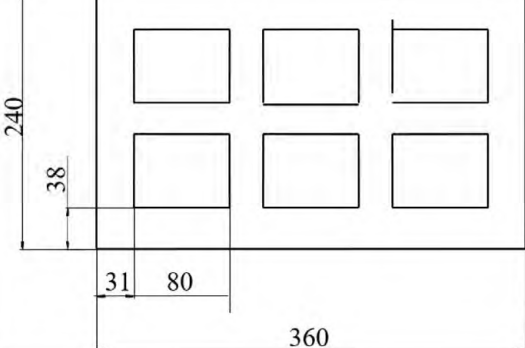
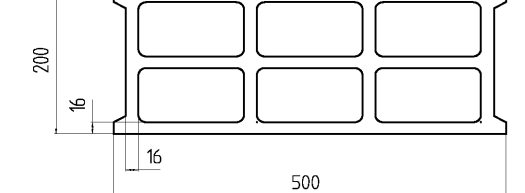
Base material	Format/ Dimensions (L x W x H) [mm]	Brick drawing [mm]	Mean compressive strength as per EN 771 [N/mm ²] / bulk density ρ [kg/dm ³]	See Annex
Hollow brick light-weight concrete Hbl as per EN 771-3, e.g. <i>Knobel, DE</i>	500 x 240 x 240		≥ 2,5 / ≥ 0,8	C 40
Hollow brick light-weight concrete Hbl as per EN 771-3, e.g. <i>KLB, DE</i>	360 x 250 x 250		≥ 2,5 / ≥ 0,9	C 41
Hollow brick light-weight concrete Hbl as per EN 771-3, e.g. <i>KLB, DE</i>	360 x 240 x 240		≥ 2,5 / ≥ 1,0	C 41
Hollow brick light-weight concrete Hbl as per EN 771-3, e.g. <i>Sepa Parpaing, FR</i>	500 x 200 x 200		≥ 2,5 / ≥ 0,9	C 41

¹⁾ Vertically perforation > 15 % and ≤ 50 %, cross section reduced by perforation vertically to the resting area.

Figures not to scale

fischer frame fixing SXR / SXRL

Performances
 Summary of base materials hollow or perforated bricks

Annex C 14

Appendix 26 / 57

Table C15.1: Summary of hollow or perforated bricks – base material group “c”¹⁾

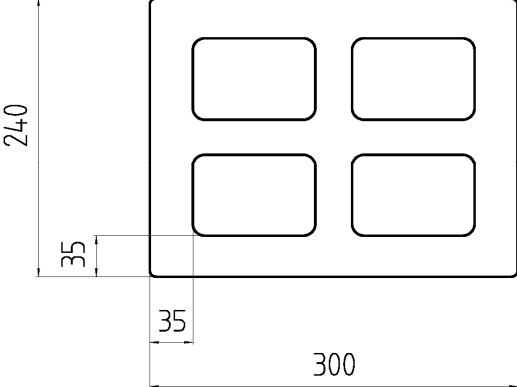
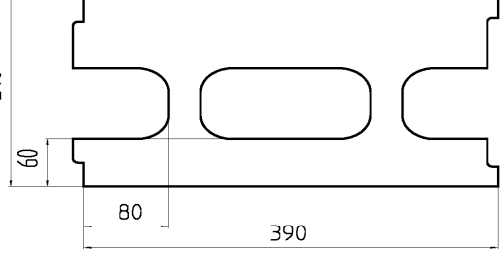
Base material	Format/ Dimensions (L x W x H) [mm]	Brick drawing [mm]	Mean compressive strength as per EN 771 [N/mm ²] / bulk density ρ [kg/dm ³]	See Annex
Hollow brick normal concrete Hbn as per EN 771-3, e.g. <i>Adolf Blatt, DE</i>	300 x 240 x 240		≥ 2,5 / ≥ 1,6	C 42
Heat insulation brick WDB e.g. <i>Gisoton, DE</i>	390 x 240 x 240		≥ 2,5 / ≥ 0,7	C 42

¹⁾ Vertically perforation > 15 % and ≤ 50 %, cross section reduced by perforation vertically to the resting area.

Table C15.2: Summary of autoclaved aerated concrete – base material group “d”

Base material	Format [mm]	Dimensions (L x W x H) [mm]	Mean compressive strength as per EN 771 [N/mm ²]	Bulk density ρ [kg/dm ³]	See Annex
Unreinforced autoclaved aerated concrete, as per EN 771-4					C 44
Reinforced autoclaved aerated concrete, AAC as per EN 12602					C 45

Figures not to scale

fischer frame fixing SXR / SXRL

Performances

Summary of base materials hollow or perforated bricks and autoclaved aerated concrete

Annex C 15

Appendix 27 / 57

Footnotes for Annex C 17 – C 43

- 1) In absence of other national regulations.
- 2) Only valid for temperature range 30/50 °C.
- 3) Only valid for edge distance $c \geq 150$ mm; intermediate values by linear interpolation.
- 4) Only valid for edge distance $c \geq 200$ mm; intermediate values by linear interpolation.
- 5) Only valid for edge distance $c \geq 150$ mm for temperature range 30/50° C; intermediate values by linear interpolation.
- 6) Only valid for edge distance $c \geq 200$ mm for temperature range 30/50° C; intermediate values by linear interpolation.
- 7) Only valid for spacing $s \geq 250$ mm
- 8) Only valid for spacing $s \geq 250$ mm for temperature range 30/50° C
- 9) The characteristic resistance F_{Rk} of lower h_{nom} can also be taken for next higher h_{nom} .
- 10) No performance assessed.
- 11) The characteristic resistance F_{Rk} is taken from the lower compressive strength of the masonry unit.
- 12) The characteristic resistance F_{Rk} is only valid for shear loads V without lever arm, for single anchors with $s_{min} \geq 250$ mm in the header side.
- 13) Only valid for $h_{min} \geq 248$ mm.
- 14) The compressive strength of the single brick must not be less than 80% of the mean compressive strength.
- 15) The lowest load of two consecutive embedment depths may be used for the intermediate embedment depths.
- 16) If the compressive strength of the base material according to EN 771-1, EN 771-2 or EN 771-3 on the construction side is lower than the mean compressive strength given in the tables according to Annex C 17 – C 43, F_{Rk} shall be calculated as follows:

$$F_{Rk, construction\ site} = F_{Rk} (Table\ C.\ "X") \cdot \frac{\text{Mean compressive strength (construction site)}}{\text{Mean compressive strength (Table C."X")}}$$

Detailed design of header side and stretcher side

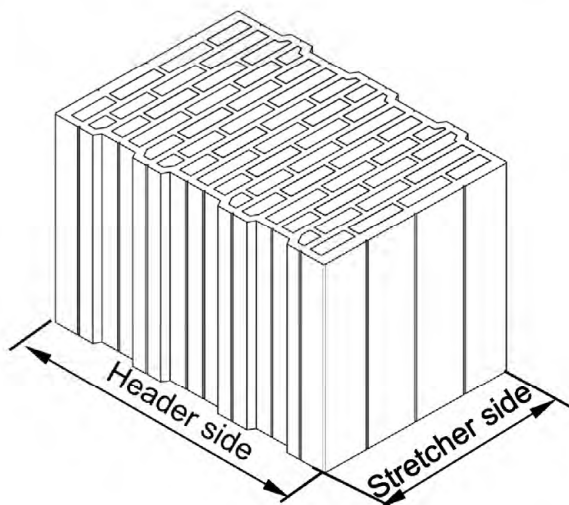

Possible position of the anchor in the header side of brick e.g. S9 (see Annex C 8, C 43)

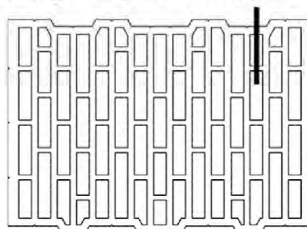

Possible Position of the anchor in the stretcher side of brick e.g. S9 (see Annex C 8, C 32)

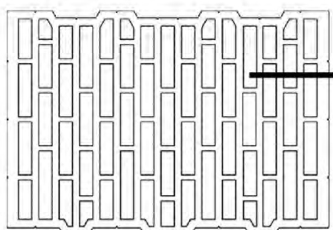

fischer frame fixing SXR / SXRL

Performances

Footnotes

Detailed design of header and stretcher side fixing, possible positions of anchor in the brick

Annex C 16

Appendix 28 / 57

Table C17.1: Characteristic resistance $F_{Rk}^{16)}$ in [kN] for use in solid masonry - base material group "b"

Base material; bulk density [kg/dm ³] [Supplier Title, country] Geometry, DF or nominal Size (L x W x H) [mm] and drilling method	Mean compressive strength as per EN 771-1 / Minimum compressive strength single brick ¹⁴⁾ [N/mm ²]	Characteristic resistance F_{Rk} [kN] Temperature range 30/50 °C and 50/80 °C								
		SXR 8	SXRL 8			SXR 10	SXRL 10		SXRL 14	
		h_{nom} [mm]								
		≥ 50	≥ 50	≥ 70	≥ 90	≥ 50	≥ 50	≥ 70	≥ 70	≥ 90
Clay brick Mz; $\rho \geq 1,8$ as per EN 771-1 e.g. <i>Schlagmann, DE</i> 3 DF (240x175x113) Hammer drilling	10/8	0,90 1,20²⁾	10)	10)	10)	0,90 1,50⁴⁾	10)	10)	10)	10)
	12,5/10	1,20 1,50²⁾	10)	10)	10)	1,20 1,50⁴⁾ 2,00⁶⁾	10)	10)	10)	10)
	15/12	1,50 2,00²⁾	10)	10)	10)	1,50 2,00⁴⁾ 2,50⁶⁾	10)	10)	10)	10)
	20/16	2,00 2,50²⁾	10)	10)	10)	2,00 2,50⁴⁾ 3,00⁶⁾	10)	10)	10)	10)
	24,7	2,50 3,00²⁾	10)	10)	10)	2,50 3,50⁴⁾ 4,00⁶⁾	10)	10)	10)	10)
Clay brick Mz; $\rho \geq 1,8$ as per EN 771-1 e.g. <i>Wienerberger, DK</i> DF (240x115x52) Hammer drilling	10/8	0,90⁷⁾	0,90 1,20⁴⁾	0,90 1,20²⁾	9)	10)	1,50⁷⁾	10)	10)	10)
	12,5/10	0,90⁷⁾ 1,20⁸⁾	1,20 1,50³⁾	1,20 1,50²⁾	9)	1,20⁷⁾	2,00⁷⁾	2,00⁷⁾	10)	10)
	15/12	1,20⁷⁾ 1,50⁸⁾	1,20 1,50²⁾ 2,00⁴⁾	1,50 2,00²⁾	9)	1,20⁷⁾ 1,50⁸⁾	2,50⁷⁾	2,00⁷⁾ 2,50⁸⁾	10)	10)
	20/16	1,50⁷⁾ 2,00⁸⁾	1,50 2,00²⁾ 2,50⁴⁾	2,00 2,50²⁾	9)	1,50⁷⁾ 2,00⁸⁾	3,50⁷⁾	3,00⁷⁾	10)	10)
	25/20	2,00⁷⁾ 2,50⁸⁾	2,00 2,50²⁾ 3,00⁴⁾ 3,50⁶⁾	2,50 3,50²⁾	9)	2,00⁷⁾ 2,50⁸⁾	4,00⁷⁾ 4,50⁵⁾⁷⁾	4,00⁷⁾	10)	10)
	26,7	2,00⁷⁾ 2,50⁸⁾	2,50 3,00⁴⁾ 3,50⁶⁾	3,00 3,50²⁾	9)	2,00⁷⁾ 2,50⁸⁾	4,00⁷⁾ 4,50³⁾⁷⁾ 5,00⁵⁾⁷⁾	4,00⁷⁾	10)	10)
	35/28	3,00⁷⁾	11)	11)	11)	3,00⁷⁾ 3,50⁸⁾	11)	5,50⁷⁾	10)	10)
	45/36	3,00⁷⁾	11)	11)	11)	4,00⁷⁾ 4,50⁸⁾	11)	6,50⁷⁾ 7,00⁸⁾	10)	10)
Partial factor	$\gamma_{Mm}^{1)}$ [-]	2,5								

Footnotes see Annex C 16.

fischer frame fixing SXR / SXRL

Performances

Characteristic resistance for use in solid masonry

Annex C 17

Appendix 29 / 57

Table C18.1: Characteristic resistance $F_{Rk}^{16)}$ in [kN] for use in solid masonry - base material group "b"

Base material; bulk density [kg/dm ³] [Supplier Title, country] Geometry, DF or nominal Size (L x W x H) [mm] and drilling method	Mean compressive strength as per EN 771 / Minimum compressive strength single brick ¹⁴⁾ [N/mm ²]	Characteristic resistance F_{Rk} [kN] Temperature range 30/50 °C and 50/80 °C								
		SXR 8	SXRL 8		SXR 10	SXRL 10		SXRL 14		
		h_{nom} [mm]								
		≥ 50	≥ 50	≥ 70	≥ 90	≥ 50	≥ 50	≥ 70	≥ 70	≥ 90
Clay brick Mz; $\rho \geq 1,8$ as per EN 771-1 e.g. Schlagmann, DE e.g. Ebersdobler, DE NF (240x115x71) Hammer drilling	10/8	0,75 ⁷⁾ 0,90 ⁸⁾	0,90	1,20 1,50 ²⁾	9)	10)	1,20 ⁷⁾ 1,50 ⁸⁾	3,00 3,50 ⁴⁾⁷⁾	1,50 2,00 ⁶⁾	9)
	12,5/10	0,90 ⁷⁾ 1,20 ⁸⁾	1,20	1,50 2,00 ²⁾	9)	0,90 ⁷⁾ 1,20 ³⁾⁷⁾	1,50 ⁷⁾ 2,00 ⁸⁾	3,50 4,00 ⁷⁾ 4,50 ⁴⁾⁷⁾	2,00 2,50 ⁶⁾	9)
	15/12	1,20 ⁷⁾ 1,50 ⁸⁾	1,50	2,00 2,50 ²⁾	9)	1,20 ⁷⁾ 1,50 ⁸⁾	2,00 ⁷⁾	4,00 4,50 ²⁾ 5,50 ⁴⁾⁷⁾	2,50 3,00 ⁶⁾	9)
	18,5/-	1,20 ⁷⁾ 1,50 ⁸⁾	1,50	2,00 2,50 ²⁾	9)	1,20 ⁷⁾ 1,50 ⁸⁾	2,00 ⁷⁾	5,00 5,50 ²⁾ 6,00 ⁷⁾ 6,50 ⁴⁾⁷⁾ 7,00 ⁶⁾⁸⁾	2,50 3,00 ⁶⁾	9)
	20/16	1,50 ⁷⁾ 2,00 ⁸⁾	2,00	2,50 3,50 ²⁾	9)	1,50 ⁷⁾ 2,00 ⁸⁾	2,50 ⁷⁾ 3,00 ⁸⁾	11)	3,00 3,50 ²⁾	9)
	25/20	2,00 ⁷⁾ 2,50 ⁸⁾	2,50	3,00 4,00 ²⁾	9)	2,00 ⁷⁾ 2,50 ⁸⁾	3,50 ⁷⁾	11)	4,00 4,50 ²⁾	9)
	35/28	2,50 ⁷⁾ 3,00 ⁸⁾	3,00 3,50 ²⁾	4,50 5,00 ²⁾	9)	3,00 ⁷⁾ 3,50 ⁸⁾	4,50 ⁷⁾ 5,00 ⁸⁾	11)	5,50 6,00 ²⁾ 6,50 ⁶⁾	9)
	35,4	3,00 ⁷⁾	3,00 3,50 ²⁾	4,50 5,00 ²⁾	9)	3,00 ⁷⁾ 3,50 ⁸⁾	4,50 ⁷⁾ 5,00 ⁸⁾	11)	5,50 6,00 ²⁾ 6,50 ⁶⁾	9)
	38,4	11)	3,50 4,00 ²⁾	5,00	9)	3,50 ⁷⁾ 4,00 ⁸⁾	5,00 ⁷⁾	11)	6,00 7,00 ⁵⁾	9)
	45/36	11)	11)	11)	11)	4,00 ⁷⁾ 4,50 ⁸⁾	11)	11)	11)	11)
	60/48	11)	11)	11)	11)	5,00 ⁷⁾	11)	11)	11)	11)
			11)	11)	11)	11)	5,00 ⁷⁾	11)	11)	11)
Partial factor	$\gamma_{Mm}^{1)}$ [-]	2,5								

Footnotes see Annex C 16.

fischer frame fixing SXR / SXRL

Performances

Characteristic resistance for use in solid masonry

Annex C 18

Appendix 30 / 57

Table C19.1: Characteristic resistance $F_{Rk}^{16)}$ in [kN] for use in solid masonry - base material group "b"

Base material; bulk density [kg/dm ³] [Supplier Title, country] Geometry, DF or nominal Size (L x W x H) [mm] and drilling method	Mean compressive strength as per EN 771 / Minimum compressive strength single brick ¹⁴⁾ [N/mm ²]	Characteristic resistance F_{Rk} [kN] Temperature range 30/50 °C and 50/80 °C								
		SXR 8	SXRL 8		SXR 10	SXRL 10		SXRL 14		
		h _{nom} [mm]								
		≥ 50	≥ 50	≥ 70	≥ 90	≥ 50	≥ 50	≥ 70	≥ 70	≥ 90
Clay brick Mz; $\rho \geq 2,2$ as per EN 771-1 e.g. <i>Schlagmann, DE</i> 2 DF (240x115x113) Hammer drilling	10/8	10)	10)	10)	10)	1,20 ⁷⁾	10)	10)	10)	10)
	12,5/10	10)	10)	10)	10)	1,50 ⁷⁾	10)	10)	10)	10)
	15/12	10)	10)	10)	10)	1,50 ⁷⁾ 2,00 ⁸⁾	10)	10)	10)	10)
	20/16	10)	10)	10)	10)	2,00 ⁷⁾ 2,50 ⁸⁾	10)	10)	10)	10)
	25/20	10)	10)	10)	10)	3,00 ⁷⁾	10)	10)	10)	10)
	26,4	10)	10)	10)	10)	3,00 ⁷⁾ 3,50 ⁸⁾	10)	10)	10)	10)
Calcium silicate solid brick KS; $\rho \geq 1,8$ as per EN 771-2 e.g. <i>KS Wemding, DE</i> NF (240x115x71) Hammer drilling	10/8	1,20	0,50 0,75 ⁷⁾ 0,90 ⁸⁾	0,50 0,60 ⁷⁾ 0,90 ⁸⁾	9)	0,90 ⁷⁾ 2,00 ⁴⁾⁷⁾	10)	1,50 2,00 ⁴⁾	1,20 1,50 ⁷⁾	9)
	12,5/10	1,20 1,50 ²⁾	0,60 0,90 ⁷⁾ 1,20 ⁸⁾	0,60 0,75 ⁷⁾ 0,90 ⁸⁾	9)	1,20 ⁷⁾ 2,00 ⁴⁾⁷⁾ 2,50 ⁶⁾⁸⁾	10)	2,00 2,50 ⁴⁾	1,50 2,00 ⁷⁾	9)
	15/12	1,50 2,00 ²⁾	0,75 1,20 ⁷⁾	0,75 0,90 ⁷⁾ 1,20 ⁸⁾	9)	1,50 ⁷⁾ 2,50 ⁴⁾⁷⁾ 3,00 ⁶⁾⁸⁾	10)	2,50 3,00 ⁴⁾	2,00 2,50 ⁸⁾	9)
	20/16	2,00 2,50 ²⁾	0,90 1,50 ⁷⁾	0,90 1,20 ⁷⁾ 1,50 ⁸⁾	9)	2,00 ⁷⁾ 3,50 ⁴⁾⁷⁾ 4,00 ⁶⁾⁸⁾	10)	3,50 4,00 ⁴⁾ 4,50 ⁶⁾	2,50 3,00 ⁷⁾ 3,50 ⁸⁾	9)
	25/20	2,50 3,00 ²⁾	1,20 2,00 ⁷⁾	1,20 1,50 ⁷⁾ 2,00 ⁸⁾	9)	2,50 ⁷⁾ 4,50 ⁴⁾⁷⁾ 5,00 ⁶⁾⁸⁾	10)	4,00 5,00 ⁴⁾ 5,50 ⁶⁾	3,00 3,50 ⁷⁾ 4,50 ⁸⁾	9)
	27,0	2,50 3,00 ²⁾	1,20 2,00 ⁷⁾	1,20 1,50 ⁷⁾ 2,00 ⁸⁾	9)	3,00 ⁷⁾ 5,00 ⁴⁾⁷⁾	10)	4,00 5,00 ⁴⁾ 5,50 ⁶⁾	3,00 3,50 ⁷⁾ 4,50 ⁸⁾	9)
	35/28	3,00	2,00 2,50 ⁷⁾ 3,00 ⁸⁾	2,00 3,00 ⁸⁾	9)	11)	10)	5,50 6,00 ³⁾ 6,50 ⁴⁾ 7,50 ⁶⁾	4,50 5,50 ⁷⁾ 6,00 ⁸⁾	9)
	37,4/-	3,00	2,00 3,00 ⁷⁾	2,00 2,50 ⁷⁾ 3,00 ⁸⁾	9)	11)	10)	5,50 6,00 ³⁾ 6,50 ⁴⁾ 8,00 ⁶⁾	5,00 5,50 ⁷⁾ 6,00 ⁸⁾ 6,50 ⁵⁾⁸⁾	9)
Partial factor	$\gamma_{Mm}^{1)}$ [-]	2,5								

Footnotes see Annex C 16.

fischer frame fixing SXR / SXRL

Performances

Characteristic resistance for use in solid masonry

Annex C 19

Appendix 31 / 57

Table C20.1: Characteristic resistance $F_{Rk}^{16)}$ in [kN] for use in solid masonry - base material group "b"

Base material; bulk density [kg/dm ³] [Supplier Title, country] Geometry, DF or nominal Size (L x W x H) [mm] and drilling method	Mean compressive strength as per EN 771 / Minimum compressive strength single brick ¹⁴⁾ [N/mm ²]	Characteristic resistance F_{Rk} [kN] Temperature range 30/50 °C and 50/80 °C								
		SXR 8	SXRL 8		SXR 10	SXRL 10		SXRL 14		
		h _{nom} [mm]								
		≥ 50	≥ 50	≥ 70	≥ 90	≥ 50	≥ 50	≥ 70	≥ 70	≥ 90
Calcium silicate solid brick KS; ρ ≥ 2,0 as per EN 771-2 e.g. <i>KS Wemding, DE</i> NF (240x115x71) Hammer drilling	10/8	1,20 1,50²⁾	10)	10)	10)	0,90	1,20⁷⁾	9)	10)	10)
	12,5/10	1,20 1,50²⁾	10)	10)	10)	1,20	1,50⁷⁾	9)	10)	10)
	15/12	1,50 2,00²⁾	10)	10)	10)	1,20 1,50²⁾	1,50⁷⁾ 2,00⁸⁾	9)	10)	10)
	20/16	2,00 2,50²⁾	10)	10)	10)	1,50 2,00²⁾	2,00⁷⁾ 2,50⁸⁾	9)	10)	10)
	25/20	2,50 3,00²⁾	10)	10)	10)	2,00 2,50²⁾	3,00⁷⁾	9)	10)	10)
	35/28	3,00	10)	10)	10)	3,00 3,50²⁾	4,00⁷⁾ 4,50⁸⁾	9)	10)	10)
	37,2/-	3,00	10)	10)	10)	3,00 3,50²⁾	4,00⁷⁾ 4,50⁸⁾	9)	10)	10)
	45/36	11)	10)	10)	10)	4,00 4,50²⁾	11)	11)	10)	10)
	54,6/-	11)	10)	10)	10)	5,00	11)	11)	10)	10)
Calcium silicate solid brick KS; ρ ≥ 2,0 as per EN 771-2 e.g. <i>Bayer Esslingen, Hermann Peter, DE</i> 2 DF (240x115x113) Hammer drilling	10/8	10)	10)	10)	10)	10)	2,00 2,50²⁾	9)	10)	10)
	12,5/10	10)	10)	10)	10)	10)	2,50 3,00²⁾	9)	10)	10)
	15/12	10)	10)	10)	10)	10)	3,00	9)	10)	10)
	20/16	10)	10)	10)	10)	10)	3,50	9)	10)	10)
Partial factor	$\gamma_{Mm}^{1)}$ [-]	2,5								

Footnotes see Annex C 16.

fischer frame fixing SXR / SXRL

Performances

Characteristic resistance for use in solid masonry

Annex C 20

Appendix 32 / 57

Table C21.1: Characteristic resistance $F_{Rk}^{16)}$ in [kN] for use in solid masonry - base material group "b"

Base material; bulk density [kg/dm ³] [Supplier Title, country] Geometry, DF or nominal Size (L x W x H) [mm] and drilling method	Mean compressive strength as per EN 771 / Minimum compressive strength single brick ¹⁴⁾ [N/mm ²]	Characteristic resistance F_{Rk} [kN] Temperature range 30/50 °C and 50/80 °C								
		SXR 8	SXRL 8		SXR 10	SXRL 10		SXRL 14		
		h_{nom} [mm]								
		≥ 50	≥ 50	≥ 70	≥ 90	≥ 50	≥ 50	≥ 70	≥ 70	≥ 90
Calcium silicate solid brick KS; $\rho \geq 1,8$ as per EN 771-2 e.g. <i>KS Wemding, DE</i> 12 DF (495x175x240) Hammer drilling	10/8	10)	10)	10)	10)	10)	10)	4,00 ⁷⁾	3,50 ⁷⁾ 5,00 ³⁾⁷⁾ 5,50 ⁵⁾⁸⁾	9)
	12,5/10	10)	10)	10)	10)	10)	10)	5,00 ⁷⁾	4,00 ⁷⁾ 6,00 ³⁾⁷⁾ 6,50 ⁵⁾⁸⁾ 7,00 ⁶⁾⁸⁾	9)
	15/12	10)	10)	10)	10)	10)	10)	6,00 ⁷⁾	4,50 ⁷⁾ 7,00 ³⁾⁷⁾ 7,50 ⁴⁾⁷⁾ 8,50 ⁶⁾⁸⁾	9)
	20/16	10)	10)	10)	10)	10)	10)	6,50 ⁷⁾ 8,50 ⁸⁾	5,00 ⁷⁾ 8,50 ³⁾⁷⁾ 10,00 ⁴⁾⁷⁾	9)
	23,5/-	10)	10)	10)	10)	10)	10)	6,50 ⁷⁾ 8,50 ⁸⁾	5,50 ⁷⁾ 9,00 ³⁾⁷⁾ 10,00 ⁴⁾⁷⁾	9)
Calcium silicate solid brick KS; $\rho \geq 2,0$ as per EN 771-2 e.g. <i>KS Wemding, DE</i> 12 DF (495x175x240) Hammer drilling	10/8	1,50	10)	10)	10)	2,00	10)	10)	10)	10)
	12,5/10	1,50 2,00 ²⁾	10)	10)	10)	2,50 3,00 ²⁾	10)	10)	10)	10)
	15/12	2,00 2,50 ²⁾	10)	10)	10)	3,00 3,50 ²⁾	10)	10)	10)	10)
	20/16	3,00	10)	10)	10)	4,00 4,50 ²⁾	10)	10)	10)	10)
	25/20	3,00	10)	10)	10)	5,00	10)	10)	10)	10)
	33,9/-	3,00	10)	10)	10)	5,00	10)	10)	10)	10)
Partial factor	$\gamma_{Mm}^{1)}$ [-]	2,5								

Footnotes see Annex C 16.

fischer frame fixing SXR / SXRL

Performances

Characteristic resistance for use in solid masonry

Annex C 21

Appendix 33 / 57

Table C22.1: Characteristic resistance F_{Rk}^{16} in [kN] for use in solid masonry - base material group "b"

Base material; bulk density [kg/dm ³] [Supplier Title, country] Geometry, DF or nominal Size (L x W x H) [mm] and drilling method	Mean compressive strength as per EN 771 / Minimum compressive strength single brick ¹⁴⁾ [N/mm ²]	Characteristic resistance F_{Rk} [kN] Temperature range 30/50 °C and 50/80 °C								
		SXR 8	SXRL 8		SXR 10	SXRL 10		SXRL 14		
		h_{nom} [mm]								
		≥ 50	≥ 50	≥ 70	≥ 90	≥ 50	≥ 50	≥ 70	≥ 70	≥ 90
Calcium silicate solid brick KS; $\rho \geq 2,0$ as per EN 771-2 e.g. KS Wemding, DE 8 DF (495x115x240) Hammer drilling	10/8	10)	2,00 ⁷⁾	2,50 ⁷⁾ 3,50 ⁵⁾⁸⁾	9)	10)	2,50 ⁷⁾ 3,00 ⁶⁾⁸⁾	9)	10)	10)
	12,5/10	10)	2,50 ⁷⁾	3,00 ⁷⁾ 3,50 ³⁾⁷⁾ 4,50 ⁵⁾⁸⁾	9)	10)	3,00 ⁷⁾ 3,50 ⁴⁾⁷⁾ 4,00 ⁶⁾⁸⁾	9)	10)	10)
	15/12	10)	3,00 ⁷⁾ 3,50 ⁵⁾⁸⁾	3,00 ⁷⁾ 3,50 ³⁾⁷⁾ 5,00 ⁵⁾⁸⁾	9)	10)	3,00 ⁷⁾ 4,00 ⁴⁾⁷⁾ 4,50 ⁶⁾⁸⁾	9)	10)	10)
	20/16	10)	3,50 ⁷⁾ 4,00 ³⁾⁷⁾	4,00 ⁷⁾ 5,00 ³⁾⁷⁾	9)	10)	3,50 ⁷⁾ 5,50 ⁴⁾⁷⁾	9)	10)	10)
	22,2/-	10)	3,50 ⁷⁾ 4,00 ³⁾⁷⁾	4,00 ⁷⁾ 5,00 ³⁾⁷⁾	9)	10)	4,00 ⁷⁾ 5,50 ⁴⁾⁷⁾	9)	10)	10)
Calcium silicate solid brick KS XL-PE; $\rho \geq 2,0$ as per EN 771-2 e.g. KS Wemding, DE (998x150x498) Hammer drilling	10/8	10)	10)	10)	10)	10)	2,50	9)	10)	10)
	12,5/10	10)	10)	10)	10)	10)	3,00	9)	10)	10)
	15/12	10)	10)	10)	10)	10)	3,50	9)	10)	10)
	20/16	10)	10)	10)	10)	10)	4,50	9)	10)	10)
	25/20	10)	10)	10)	10)	10)	5,50 6,00 ¹²⁾	9)	10)	10)
	31,3/-	10)	10)	10)	10)	10)	5,50 7,50 ¹²⁾	9)	10)	10)
Partial factor	$\gamma_{Mm}^{1)}$ [-]	2,5								

Footnotes see Annex C 16.

fischer frame fixing SXR / SXRL

Performances

Characteristic resistance for use in solid masonry

Annex C 22

Appendix 34 / 57

Table C23.1: Characteristic resistance $F_{Rk}^{16)}$ in [kN] for use in solid masonry - base material group “b“

Base material; bulk density [kg/dm ³] [Supplier Title, country] Geometry, DF or nominal Size (L x W x H) [mm] and drilling method	Mean compressive strength as per EN 771 / Minimum compressive strength single brick ¹⁴⁾ [N/mm ²]	Characteristic resistance F_{Rk} [kN] Temperature range 30/50 °C and 50/80 °C								
		SXR 8	SXRL 8		SXR 10	SXRL 10		SXRL 14		
		h_{nom} [mm]								
		≥ 50	≥ 50	≥ 70	≥ 90	≥ 50	≥ 50	≥ 70	≥ 70	≥ 90
Lightweight solid brick Vbl; $\rho \geq 1,2$ as per EN 771-3 e.g. <i>KLB, DE</i> 2 DF (240x115x113) Hammer drilling	2,5/2	0,50 ⁷⁾	0,60	0,90 ³⁾ 1,20 ⁵⁾	9)	0,75 ⁷⁾ 0,90 ⁸⁾	0,50 0,60 ²⁾	9)	1,20 1,50 ²⁾	9)
	2,7/-	0,75 ⁷⁾ 0,90 ⁸⁾	0,60	1,20 ³⁾ 1,50 ⁵⁾	9)	10)	0,60	9)	2,00 2,50 ³⁾	9)
Lightweight solid brick Vbl; $\rho \geq 1,4$ as per EN 771-3 e.g. <i>KLB, DE</i> 2 DF (240x115x113) Hammer drilling	2,5/2	10)	10)	10)	10)	10)	10)	1,50 2,50 ¹²⁾	10)	10)
	5/4	10)	10)	10)	10)	10)	10)	3,50 5,00 ¹²⁾	10)	10)
Lightweight solid brick Vbl; $\rho \geq 1,0$ as per EN 771-3 e.g. <i>KLB, DE</i> 8 DF (490x115x240) Hammer drilling	2,5/2	1,20	10)	10)	10)	10)	10)	10)	10)	10)
	3,1	1,50	10)	10)	10)	10)	10)	10)	10)	10)
Lightweight solid brick Vbl; $\rho \geq 1,2$ as per EN 771-3 e.g. <i>KLB, DE</i> 8 DF (490x115x240) Hammer drilling	2,5/2	10)	10)	10)	10)	1,20	10)	10)	10)	10)
Lightweight solid brick Vbl; $\rho \geq 1,6$ as per EN 771-3 e.g. <i>KLB, DE</i> 8 DF (490x115x240) Hammer drilling	2,5/2	10)	10)	10)	10)	0,90 ⁷⁾ 1,20 ⁸⁾	10)	10)	10)	10)
	5/4	10)	10)	10)	10)	2,00 ⁷⁾ 2,00 ⁸⁾ 2,50 ⁵⁾⁸⁾	10)	10)	10)	10)
	7,5/6	10)	10)	10)	10)	2,50 ⁷⁾ 3,00 ³⁾⁷⁾ 3,50 ⁵⁾⁸⁾	10)	10)	10)	10)
	9,0/-	10)	10)	10)	10)	2,50 ⁷⁾ 3,50 ³⁾⁷⁾ 4,00 ⁵⁾⁸⁾	10)	10)	10)	10)
Partial factor	$\gamma_{Mm}^{1)}$ [-]	2,5								

Footnotes see Annex C 16.

fischer frame fixing SXR / SXRL

Performances

Characteristic resistance for use in solid masonry

Annex C 23

Appendix 35 / 57

Table C24.1: Characteristic resistance $F_{Rk}^{16)}$ in [kN] for use in solid masonry - base material group "b"

Base material; bulk density [kg/dm ³] [Supplier Title, country] Geometry, DF or nominal Size (L x W x H) [mm] and drilling method	Mean compressive strength as per EN 771 / Minimum compressive strength single brick ¹⁴⁾ [N/mm ²]	Characteristic resistance F_{Rk} [kN] Temperature range 30/50 °C and 50/80 °C								
		SXR 8	SXRL 8		SXR 10	SXRL 10		SXRL 14		
		h _{nom} [mm]								
		≥ 50	≥ 50	≥ 70	≥ 90	≥ 50	≥ 50	≥ 70	≥ 70	≥ 90
Lightweight solid brick Vbl; $\rho \geq 1,8$ as per EN 771-3 e.g. KLB, DE 8 DF (490x240x115) Hammer drilling	5/4	1,50 ⁷⁾ 2,00 ⁵⁾⁸⁾	10)	10)	10)	10)	10)	2,00 ⁷⁾	10)	10)
	7,5/6	2,00 ⁷⁾ 2,50 ³⁾⁷⁾	10)	10)	10)	10)	10)	2,50 ⁷⁾ 3,00 ⁵⁾⁸⁾	10)	10)
	10/8	2,50 ⁷⁾ 3,00 ³⁾⁷⁾	10)	10)	10)	10)	10)	3,00 ⁷⁾ 3,50 ³⁾⁷⁾	10)	10)
	12,5/10	2,50 ⁷⁾	10)	10)	10)	10)	10)	3,00 ⁷⁾ 4,50 ³⁾⁷⁾	10)	10)
	13,42/-	3,00 ⁷⁾	10)	10)	10)	10)	10)	3,50 ⁷⁾ 5,00 ³⁾⁷⁾	10)	10)
Lightweight solid brick Vbl; $\rho \geq 1,4$ as per EN 771-3 e.g. KLB, DE 8 DF (245x240x240) Hammer drilling	5/4	0,50 ⁷⁾ 0,60 ⁸⁾	10)	10)	10)	2,00 ⁷⁾	10)	10)	10)	10)
	7,5/6	0,75 ⁷⁾ 0,90 ⁸⁾	10)	10)	10)	2,50 ⁷⁾	10)	10)	10)	10)
	8,65/-	0,90 ⁷⁾	10)	10)	10)	2,50 ⁷⁾	10)	10)	10)	10)
Lightweight solid brick Vbl; $\rho \geq 1,6$ as per EN 771-3 e.g. KLB, DE 8 DF (245x240x240) Hammer drilling	2,5/2	10)	0,60 ⁷⁾ 0,75 ⁸⁾	0,90 ⁷⁾ 1,20 ⁸⁾	9)	1,20 ⁷⁾ 1,50 ⁵⁾⁸⁾	0,90 ⁷⁾ 1,20 ⁶⁾⁸⁾	2,00 ⁷⁾	1,50 ⁷⁾ 2,00 ³⁾⁷⁾	9)
	5/4	10)	1,20 ⁷⁾ 1,50 ⁸⁾	2,00 ⁷⁾ 2,50 ⁵⁾⁸⁾	9)	2,00 ⁷⁾ 2,50 ³⁾⁷⁾ 3,00 ⁵⁾⁸⁾	2,00 ⁷⁾	3,50 ⁷⁾ 4,00 ⁸⁾ 4,50 ¹²⁾	2,50 ⁷⁾ 3,50 ³⁾⁷⁾ 4,50 ⁵⁾⁸⁾	9)
	7,5/6	10)	2,00 ⁷⁾	2,50 ⁷⁾ 3,00 ³⁾⁷⁾ 4,00 ⁵⁾⁸⁾	9)	2,50 ⁷⁾ 4,00 ³⁾⁷⁾ 4,50 ⁵⁾⁸⁾	2,50 ⁷⁾ 3,00 ⁴⁾⁵⁾⁷⁾ 3,50 ⁶⁾⁸⁾	5,50 ⁷⁾ 6,00 ⁸⁾ 6,50 ¹²⁾	3,00 ⁷⁾ 5,50 ³⁾⁷⁾ 6,50 ⁶⁾⁸⁾	9)
	10/8	10)	2,50 ⁷⁾	3,00 ⁷⁾ 4,00 ³⁾⁷⁾ 5,00 ⁵⁾⁸⁾	9)	2,50 ⁷⁾ 4,00 ³⁾⁷⁾ 4,50 ⁵⁾⁸⁾	3,00 ⁷⁾ 3,50 ³⁾⁷⁾ 4,00 ⁴⁾⁵⁾⁷⁾ 4,50 ⁶⁾⁸⁾	7,50 ⁷⁾ 8,00 ⁸⁾ 9,00 ¹²⁾	3,50 ⁷⁾ 6,50 ³⁾⁷⁾ 7,50 ⁴⁾⁷⁾ 8,50 ⁶⁾⁸⁾	9)
	11/-	10)	2,50 ⁷⁾ 3,00 ⁸⁾	3,00 ⁷⁾ 4,50 ³⁾⁷⁾ 5,00 ⁵⁾⁸⁾	9)	11)	3,00 ⁷⁾ 4,00 ³⁾⁷⁾ 4,50 ⁴⁾⁵⁾⁷⁾ 5,00 ⁶⁾⁸⁾	6,50 ⁷⁾ 8,50 ⁸⁾ 10,00 ¹²⁾	4,00 ⁷⁾ 7,00 ³⁾⁷⁾ 8,00 ⁴⁾⁷⁾ 9,50 ⁶⁾⁸⁾	9)
Partial factor	$\gamma_{Mm}^{1)}$ [-]	2,5								

Footnotes see Annex C 16.

fischer frame fixing SXR / SXRL

Performances

Characteristic resistance for use in solid masonry

Annex C 24

Appendix 36 / 57

Table C25.1: Characteristic resistance F_{Rk}^{16} in [kN] for use in solid masonry - base material group "b"

Base material; bulk density [kg/dm ³] [Supplier Title, country] Geometry, DF or nominal Size (L x W x H) [mm] and drilling method	Mean compressive strength as per EN 771 / Minimum compressive strength single brick ¹⁴⁾ [N/mm ²]	Characteristic resistance F_{Rk} [kN] Temperature range 30/50 °C and 50/80 °C								
		SXR 8	SXRL 8		SXR 10	SXRL 10		SXRL 14		
		h_{nom} [mm]								
		≥ 50	≥ 50	≥ 70	≥ 90	≥ 50	≥ 50	≥ 70	≥ 70	≥ 90
Lightweight solid brick Vbl; $\rho \geq 0,8$ as per EN 771-3, e.g. <i>Liapor Super-K, DE</i> 16 DF (500x240x248) Hammer drilling	1,8/2	10)	10)	10)	10)	10)	10)	0,40⁷⁾	10)	10)
	2,2/-	10)	10)	10)	10)	10)	10)	0,50⁷⁾	10)	10)
Lightweight solid brick Vbl; $\rho \geq 1,4$ as per EN 771-3, e.g. <i>Tarmac, UK</i> (440x100x215) Hammer drilling	2,5/2	10)	10)	10)	10)	0,90⁷⁾	10)	1,20⁷⁾	10)	10)
	5/4	10)	10)	10)	10)	1,50⁷⁾	10)	2,00⁷⁾ 2,50⁴⁾⁷⁾	10)	10)
	7,3/-	10)	10)	10)	10)	2,00⁷⁾ 2,50³⁾⁷⁾ 3,00⁵⁾⁸⁾	10)	2,00⁷⁾ 3,50⁴⁾⁷⁾ 4,00⁶⁾⁸⁾	10)	10)
Solid brick normal concrete Vbn; $\rho \geq 1,8$ as per EN 771-3 e.g. <i>Adolf Blatt, DE</i> (240x245x240) Hammer drilling	5/4	1,50⁷⁾	10)	10)	10)	1,50⁷⁾ 2,00⁸⁾	10)	10)	10)	10)
	7,5/6	2,00⁷⁾ 2,50⁸⁾	10)	10)	10)	2,50⁷⁾ 3,00⁵⁾⁸⁾	10)	10)	10)	10)
	10/8	3,00⁷⁾	10)	10)	10)	3,00⁷⁾ 3,50³⁾⁷⁾ 4,00⁵⁾⁸⁾	10)	10)	10)	10)
	12,5/10	3,00⁷⁾	10)	10)	10)	3,50⁷⁾ 4,00³⁾⁷⁾ 5,00⁵⁾⁸⁾	10)	10)	10)	10)
	15/12	3,00⁷⁾	10)	10)	10)	3,50⁷⁾ 5,00³⁾⁷⁾ 5,00⁵⁾⁸⁾	10)	10)	10)	10)
	17,0/-	3,00⁷⁾	10)	10)	10)	4,00⁷⁾ 5,00³⁾⁷⁾ 5,00⁵⁾⁸⁾	10)	10)	10)	10)
Partial factor	$\gamma_{Mm}^{1)}$ [-]	2,5								

Footnotes see Annex C 16.

fischer frame fixing SXR / SXRL

Performances

Characteristic resistance for use in solid masonry

Annex C 25

Appendix 37 / 57

Table C26.1: Characteristic resistance $F_{Rk}^{16)}$ in [kN] for use in solid masonry - base material group "b"

Base material; bulk density [kg/dm ³] [Supplier Title, country] Geometry, DF or nominal Size (L x W x H) [mm] and drilling method	Mean compressive strength as per EN 771 / Minimum compressive strength single brick ¹⁴⁾ [N/mm ²]	Characteristic resistance F_{Rk} [kN] Temperature range 30/50 °C and 50/80 °C								
		SXR 8	SXRL 8		SXR 10	SXRL 10		SXRL 14		
		h_{nom} [mm]								
		≥ 50	≥ 50	≥ 70	≥ 90	≥ 50	≥ 50	≥ 70	≥ 70	≥ 90
Solid brick normal concrete Vbn; $\rho \geq 1,8$ as per EN 771-3 e.g. Tarmac, UK (440x100x215) Hammer drilling	7,5/6	10)	10)	10)	10)	1,50 ⁷⁾ 2,00 ⁸⁾	10)	2,50 ⁷⁾ 4,50 ¹²⁾	10)	10)
	10/8	10)	10)	10)	10)	2,00 ⁷⁾ 2,50 ⁸⁾	10)	3,50 ⁷⁾ 6,00 ¹²⁾	10)	10)
	12,5/10	10)	10)	10)	10)	2,50 ⁷⁾ 3,00 ⁵⁾⁸⁾	10)	4,00 ⁷⁾ 4,50 ⁸⁾ 7,50 ¹²⁾	10)	10)
	15/12	10)	10)	10)	10)	3,00 ⁷⁾ 3,50 ⁵⁾⁸⁾	10)	5,00 ⁷⁾ 9,00 ¹²⁾	10)	10)
	18,0/-	10)	10)	10)	10)	3,50 ⁷⁾ 4,00 ³⁾⁷⁾ 4,50 ⁵⁾⁸⁾	10)	6,00 ⁷⁾ 6,50 ⁸⁾ 11,00 ¹²⁾	10)	10)
Partial factor	$\gamma_{Mm}^{1)}$ [-]	2,5								

Footnotes see Annex C 16.

Table C26.2: Characteristic resistance $F_{Rk}^{16)}$ in [kN] for use in hollow or perforated brick masonry – base material group "c"

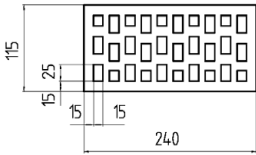
Base material; bulk density [kg/dm ³] [Supplier Title, country] Geometry, DF or nominal Size (L x W x H) [mm] and drilling method	Mean compressive strength as per EN 771 / Minimum compressive strength single brick ¹⁴⁾ [N/mm ²]	Characteristic resistance F_{Rk} [kN] Temperature range 30/50 °C and 50/80 °C								
		SXR 8	SXRL 8		SXR 10	SXRL 10		SXRL 14		
		h_{nom} [mm]								
		50	50	70	90	50	50	70	70	90
Perforated clay brick HLz; $\rho \geq 1,2$ Form B, as per EN 771-1 e.g. Wienerberger, DE  2 DF (240x115x113) Rotary drilling	10/8	0,40 ⁷⁾ 0,50 ⁸⁾	10)	10)	10)	0,90 ⁷⁾	10)	0,90 ⁷⁾	10)	10)
	12,5/10	0,60 ⁷⁾	10)	10)	10)	1,20 ⁷⁾	10)	1,20 ⁷⁾	10)	10)
	15/12	0,60 ⁷⁾ 0,75 ⁸⁾	10)	10)	10)	1,50 ⁷⁾	10)	1,50 ⁷⁾	10)	10)
	20/16	0,90 ⁷⁾	10)	10)	10)	2,00 ⁷⁾	10)	2,00 ⁷⁾	10)	10)
	25/20	1,20 ⁷⁾	10)	10)	10)	2,50 ⁷⁾	10)	2,50 ⁷⁾	10)	10)
	26,7/-	1,20 ⁷⁾ 1,50 ⁸⁾	10)	10)	10)	2,50 ⁷⁾	10)	2,50 ⁷⁾	10)	10)
Partial factor	$\gamma_{Mm}^{1)}$ [-]	2,5								

Footnotes see Annex C 16.

fischer frame fixing SXR / SXRL

Performances

Characteristic resistance for use in solid masonry, hollow or perforated masonry

Annex C 26

Appendix 38 / 57

Table C27.1: Characteristic resistance $F_{Rk}^{16)}$ in [kN] for use in hollow or perforated brick masonry – base material group “c”

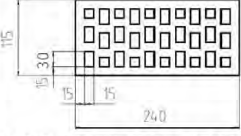
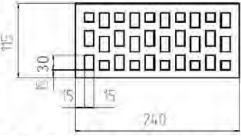
Base material; bulk density [kg/dm ³] [Supplier Title, country] Geometry, DF or nominal Size (L x W x H) [mm] and drilling method	Mean compressive strength as per EN 771 / Minimum compressive strength single brick ¹⁴⁾ [N/mm ²]	Characteristic resistance F_{Rk} [kN] Temperature range 30/50 °C and 50/80 °C								
		SXR 8	SXRL 8 ¹⁵⁾			SXR 10	SXRL 10		SXRL 14	
		h _{nom} [mm]								
		50	50	70	90	50	50	70	70	90
Perforated clay brick HLz; $\rho \geq 1,0$ as per EN 771-1 e.g. Wienerberger, DE 	10/8	0,40⁷⁾	10)	10)	10)	0,60⁷⁾ 0,75⁸⁾	10)	0,60	10)	10)
	12,5/10	0,50⁷⁾	10)	10)	10)	0,75⁷⁾ 0,90⁸⁾	10)	0,75	10)	10)
	15/12	0,60⁷⁾	10)	10)	10)	0,90⁷⁾	10)	0,90	10)	10)
	15,6/-	0,60⁷⁾	10)	10)	10)	0,90⁷⁾ 1,20⁸⁾	10)	1,20	10)	10)
Perforated clay brick HLz; $\rho \geq 1,2$ as per EN 771-1 e.g. Wienerberger, DE 	10/8	10)	0,40⁷⁾	0,40⁷⁾ 0,50⁸⁾	0,40 0,60²⁾	10)	10)	0,60⁷⁾	10)	10)
	12,5/10	10)	0,50⁷⁾	0,50⁷⁾ 0,60⁸⁾	0,60 0,75²⁾	10)	10)	0,75⁷⁾	10)	10)
	15/12	10)	0,60⁷⁾	0,60⁷⁾ 0,75⁸⁾	0,60 0,90²⁾	10)	10)	0,90⁷⁾	10)	10)
	20/16	10)	0,75⁷⁾ 0,90⁸⁾	0,75⁷⁾ 0,90⁸⁾	0,90 1,20²⁾	10)	10)	1,20⁷⁾	10)	10)
	25/20	10)	0,90⁷⁾ 1,20⁸⁾	0,90⁷⁾ 1,20⁸⁾	1,20 1,50²⁾	10)	10)	1,50⁷⁾	10)	10)
	35/28	10)	1,20⁷⁾ 1,50⁸⁾	1,20⁷⁾ 1,75⁸⁾	1,50 2,00²⁾	10)	10)	2,00⁷⁾ 2,50⁸⁾	10)	10)
	35,9	10)	1,20⁷⁾ 1,50⁸⁾	1,50⁷⁾ 2,00⁸⁾	1,50 2,00²⁾	10)	10)	2,50⁷⁾	10)	10)
Partial factor	$\gamma_{Mm}^{1)}$ [-]	2,5								

Footnotes see Annex C 16.

fischer frame fixing SXR / SXRL

Performances

Characteristic resistance for use in hollow or perforated masonry

Annex C 27

Appendix 39 / 57

Table C28.1: Characteristic resistance $F_{Rk}^{16)}$ in [kN] for use in hollow or perforated brick masonry – base material group “c”

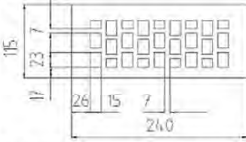
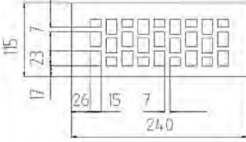
Base material; bulk density [kg/dm ³] [Supplier Title, country] Geometry, DF or nominal Size (L x W x H) [mm] and drilling method	Mean compressive strength as per EN 771 / Minimum compressive strength single brick ¹⁴⁾ [N/mm ²]	Characteristic resistance F_{Rk} [kN] Temperature range 30/50 °C and 50/80 °C								
		SXR 8	SXRL 8		SXR 10	SXRL 10		SXRL 14 ¹⁵⁾		
		h_{nom} [mm]								
		50	50	70	90	50	50	70	70	90
Perforated clay brick VHLz; $\rho \geq 1,6$ as per EN 771-1, e.g. Wienerberger, DE 	20/16	10)	10)	10)	10)	10)	10)	10)	1,50 2,00 ²⁾	1,50 2,00 ²⁾
	25/20	10)	10)	10)	10)	10)	10)	10)	2,00 2,50 ²⁾	2,00 2,50 ²⁾
	35/28	10)	10)	10)	10)	10)	10)	10)	3,00 3,50 ²⁾	2,50 3,00 ²⁾
	45/36	10)	10)	10)	10)	10)	10)	10)	4,00 4,50 ²⁾	3,50 4,00 ²⁾
	60/48	10)	10)	10)	10)	10)	10)	10)	5,00 6,00 ²⁾	4,50 5,50 ²⁾
	70,1/-	10)	10)	10)	10)	10)	10)	10)	6,00 7,00 ²⁾	5,50 6,50 ²⁾
Perforated clay brick VHLz; $\rho \geq 1,6$ as per EN 771-1, e.g. Wienerberger, DE 	12,5/10	10)	0,50 ⁷⁾ 0,60 ⁸⁾	0,50 ⁷⁾ 0,60 ⁸⁾	0,30 ⁷⁾ 0,40 ⁸⁾	0,90 ⁷⁾	10)	1,20 ⁷⁾	10)	10)
	15/12	10)	0,60 ⁷⁾ 0,75 ⁸⁾	0,60 ⁷⁾ 0,75 ⁸⁾	0,40 ⁷⁾ 0,50 ⁸⁾	0,90 ⁷⁾ 1,20 ⁸⁾	10)	1,20 ⁷⁾ 1,50 ⁸⁾	10)	10)
	20/16	10)	0,75 ⁷⁾ 0,90 ⁸⁾	0,75 ⁷⁾ 1,20 ⁸⁾	0,50 ⁷⁾ 0,60 ⁸⁾	1,50 ⁷⁾	10)	1,50 ⁷⁾ 2,00 ⁸⁾	10)	10)
	25/20	10)	0,90 ⁷⁾ 1,20 ⁸⁾	0,90 ⁷⁾ 1,20 ⁸⁾	0,60 ⁷⁾ 0,90 ⁸⁾	1,50 ⁷⁾ 2,00 ⁸⁾	10)	2,00 ⁷⁾ 2,50 ⁸⁾	10)	10)
	35/28	10)	1,50 ⁷⁾	1,50 ⁷⁾ 2,00 ⁸⁾	0,90 ⁷⁾ 1,20 ⁸⁾	2,50 ⁷⁾	10)	3,00 ⁷⁾	10)	10)
	45/36	10)	2,00 ⁷⁾	2,00 ⁷⁾	1,20 ⁷⁾ 1,50 ⁸⁾	2,50 ⁷⁾	10)	4,00 ⁷⁾	10)	10)
	60/48	10)	2,50 ⁷⁾	2,50 ⁷⁾	1,50 ⁷⁾ 2,00 ⁸⁾	2,50 ⁷⁾	10)	5,50 ⁷⁾	10)	10)
	60,7/-	10)	2,50 ⁷⁾	2,50 ⁷⁾	1,50 ⁷⁾ 2,00 ⁸⁾	2,50 ⁷⁾	10)	5,50 ⁷⁾	10)	10)
Partial factor	$\gamma_{Mm}^{1)}$ [-]	2,5								

Footnotes see Annex C 16.

fischer frame fixing SXR / SXRL

Performances

Characteristic resistance for use in hollow or perforated masonry

Annex C 28

Appendix 40 / 57

Table C29.1: Characteristic resistance $F_{Rk}^{16)}$ in [kN] for use in hollow or perforated brick masonry – base material group “c”

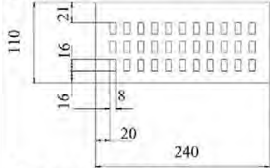
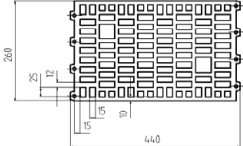
Base material; bulk density [kg/dm ³] [Supplier Title, country] Geometry, DF or nominal Size (L x W x H) [mm] and drilling method	Mean compressive strength as per EN 771 / Minimum compressive strength single brick ¹⁴⁾ [N/mm ²]	Characteristic resistance F_{Rk} [kN] Temperature range 30/50 °C and 50/80 °C								
		SXR 8	SXRL 8		SXR 10	SXRL 10		SXRL 14		
		h_{nom} [mm]								
		50	50	70	90	50	50	70	70	90
Perforated clay brick HLz; $\rho \geq 1,5$ as per EN 771 -1 e.g. <i>Wienerberger, BS, DE</i>  DF (240x110x52) Hammer drilling	10/8	0,60⁷⁾	10)	10)	10)	0,50⁷⁾ 0,60⁸⁾	10)	10)	10)	10)
	12,5/10	0,75⁷⁾	10)	10)	10)	0,60⁷⁾ 0,75⁸⁾	10)	10)	10)	10)
	15/12	0,75⁷⁾ 0,90⁸⁾	10)	10)	10)	0,75⁷⁾ 0,90⁸⁾	10)	10)	10)	10)
	20/16	1,20⁷⁾	10)	10)	10)	0,90⁷⁾ 1,20⁸⁾	10)	10)	10)	10)
	25/20	1,50⁷⁾	10)	10)	10)	1,20⁷⁾ 1,50⁸⁾	10)	10)	10)	10)
	35/28	2,00⁷⁾	10)	10)	10)	1,50⁷⁾ 2,00⁸⁾	10)	10)	10)	10)
	45/36	2,50⁷⁾	10)	10)	10)	2,00⁷⁾ 2,50⁸⁾	10)	10)	10)	10)
	48, 1/-	2,50⁷⁾	10)	10)	10)	2,50⁷⁾	10)	10)	10)	10)
Perforated clay brick HLz; $\rho \geq 0,9$ as per EN 771-1 e.g. <i>Schlagmann, DE</i>  10 DF (440x260x240) Rotary drilling	5/4	0,40 0,50²⁾	10)	10)	10)	0,60	10)	10)	10)	10)
	7,5/6	0,60 0,75²⁾	10)	10)	10)	0,90	10)	10)	10)	10)
	10/8	0,90	10)	10)	10)	1,20	10)	10)	10)	10)
	10, 9/-	0,90 1,20²⁾	10)	10)	10)	1,20 1,50²⁾	10)	10)	10)	10)
Partial factor	$\gamma_{Mm}^{1)}$ [-]	2,5								

Footnotes see Annex C 16.

fischer frame fixing SXR / SXRL

Performances

Characteristic resistance for use in hollow or perforated masonry

Annex C 29

Appendix 41 / 57

Table C30.1: Characteristic resistance $F_{Rk}^{16)}$ in [kN] for use in hollow or perforated brick masonry – base material group “c”

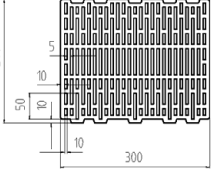
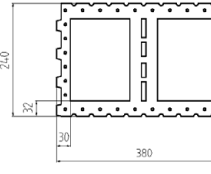
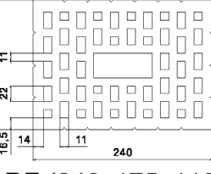
Base material; bulk density [kg/dm ³] [Supplier Title, country] Geometry, DF or nominal Size (L x W x H) [mm] and drilling method	Mean compressive strength as per EN 771 / Minimum compressive strength single brick ¹⁴⁾ [N/mm ²]	Characteristic resistance F_{Rk} [kN] Temperature range 30/50 °C and 50/80 °C								
		SXR 8	SXRL 8		SXR 10	SXRL 10		SXRL 14 ¹⁵⁾		
		h _{nom} [mm]								
		50	50	70	90	50	50	70	70	90
Perforated clay brick HLz; $\rho \geq 0,7$ as per EN 771-1 e.g. <i>Schlagmann Poroton T14, DE</i> 	5/4	10)	10)	10)	10)	0,30	10)	0,50⁷⁾	10)	10)
	6,4/-	10)	10)	10)	10)	0,30 0,40²⁾	10)	0,50⁷⁾	10)	10)
	7,5/6	10)	10)	10)	10)	0,30 0,40²⁾	10)	0,75⁷⁾	10)	10)
	7,7/-	10)	10)	10)	10)	0,30 0,40²⁾	10)	0,75⁷⁾	10)	10)
10 DF (240x300x240) Rotary drilling										
Perforated clay brick HLz; $\rho \geq 0,7$ as per EN 771-1 e.g. <i>Schlagmann Planfüllziegel, DE</i> 	2,5/2	0,40 0,50²⁾	10)	10)	10)	0,60	10)	10)	10)	10)
	5/4	0,75 0,90²⁾	10)	10)	10)	1,20	10)	10)	10)	10)
	7,5/6	1,20 1,50²⁾	10)	10)	10)	2,00	10)	10)	10)	10)
12 DF (380x240x240) Rotary drilling	8,0/-	1,20 1,50²⁾	10)	10)	10)	2,00	10)	10)	10)	10)
Perforated clay brick HLz; $\rho \geq 1,0$ as per EN 771-1 e.g. <i>Schlagmann, DE</i> 	7,5/6	10)	10)	10)	10)	10)	10)	10)	1,50⁷⁾	2,00⁷⁾
	10/8	10)	10)	10)	10)	10)	10)	10)	2,00⁷⁾	2,50⁷⁾
	12,5/10	10)	10)	10)	10)	10)	10)	10)	2,50⁷⁾	2,50⁷⁾
	15/12	10)	10)	10)	10)	10)	10)	10)	2,50⁷⁾	2,50⁷⁾
	3 DF (240x175x113) Rotary drilling	15,8/-	10)	10)	10)	10)	10)	10)	10)	2,50⁷⁾
Partial factor	$\gamma_{Mm}^{1)}$ [-]	2,5								

Footnotes see Annex C 16.

fischer frame fixing SXR / SXRL



Performances

Characteristic resistance for use in hollow or perforated masonry

Annex C 30

Appendix 42 / 57

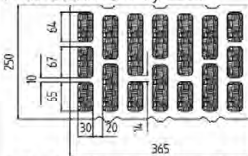
Table C31.1: Characteristic resistance F_{Rk}^{16} in [kN] for use in hollow or perforated brick masonry – base material group “c”

Base material; bulk density [kg/dm ³] [Supplier Title, country] Geometry, DF or nominal Size (L x W x H) [mm] and drilling method	Mean compressive strength as per EN 771 / Minimum compressive strength single brick ¹⁴⁾ [N/mm ²]	Characteristic resistance F_{Rk} [kN] Temperature range 30/50 °C and 50/80 °C								
		SXR 8	SXRL 8		SXR 10	SXRL 10		SXRL 14		
		h_{nom} [mm]								
		50	50	70	90	50	50	70	70	90
Perforated clay brick HLz; $\rho \geq 0,8$ as per EN 771-1 e.g. Schlagmann Poroton S11, DE 	5/4	10)	10)	10)	10)	10)	10)	1,20 ⁷⁾	10)	10)
	7,5/6	10)	10)	10)	10)	10)	10)	1,50 ⁷⁾	10)	10)
	8,6/-	10)	10)	10)	10)	10)	10)	2,00 ⁷⁾	10)	10)
Perforated clay brick HLz; $\rho \geq 0,7$ as per EN 771-1 e.g. Schlagmann Poroton S10, DE 	5/4	10)	10)	10)	10)	10)	10)	1,20 ⁷⁾ 1,50 ⁸⁾	10)	10)
	7,5/6	10)	10)	10)	10)	10)	10)	2,00 ⁷⁾	10)	10)
	7,7/-	10)	10)	10)	10)	10)	10)	2,00 ⁷⁾	10)	10)
Perforated clay brick HLz; $\rho \geq 0,6$ as per EN 771-1 e.g. Schlagmann Poroton T8, DE 	2,5/2	10)	10)	10)	10)	10)	10)	0,75 ⁷⁾	10)	10)
	5/4	10)	10)	10)	10)	10)	10)	1,50 ⁷⁾	10)	10)
	5,8/-	10)	10)	10)	10)	10)	10)	1,50 ⁷⁾	10)	10)
Partial factor	$\gamma_{Mm}^{1)}$ [-]	2,5								

Footnotes see Annex C 16.

fischer frame fixing SXR / SXRL

Performances

Characteristic resistance for use in hollow or perforated masonry

Annex C 31

Appendix 43 / 57

Table C32.1: Characteristic resistance $F_{Rk}^{16)}$ in [kN] for use in hollow or perforated brick masonry – base material group “c”

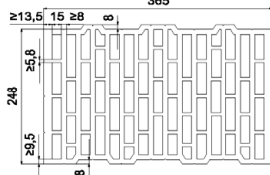
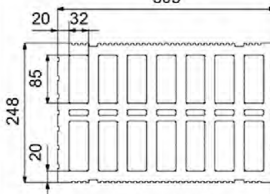
Base material; bulk density [kg/dm ³] [Supplier Title, country] Geometry, DF or nominal Size (L x W x H) [mm] and drilling method	Mean compressive strength as per EN 771 / Minimum compressive strength single brick ¹⁴⁾ [N/mm ²]	Characteristic resistance F_{Rk} [kN] Temperature range 30/50 °C and 50/80 °C								
		SXR 8	SXRL 8		SXR 10	SXRL 10		SXRL 14		
		h_{nom} [mm]								
		50	50	70	90	50	70	90	70	90
Perforated clay brick HLz; $\rho \geq 0,75$ as per EN 771-1 e.g. Schlagmann Poroton S9 Hlz, DE  (248x365x249) Rotary drilling	7,5/6	10)	10)	10)	10)	10)	0,75 1,20 ⁷⁾	0,90 1,20 ³⁾⁷⁾ 1,50 ³⁾⁸⁾	10)	10)
	10/8	10)	10)	10)	10)	10)	0,90 1,50 ⁷⁾	1,50 2,00 ³⁾⁷⁾	10)	10)
	12,5/10	10)	10)	10)	10)	10)	1,20 2,00 ⁷⁾	1,50 2,00 ³⁾⁷⁾ 2,50 ³⁾⁸⁾	10)	10)
	15/12	10)	10)	10)	10)	10)	1,50 2,50 ⁷⁾	2,00 2,50 ³⁾ 3,00 ³⁾⁸⁾	10)	10)
	16/-	10)	10)	10)	10)	10)	1,50 2,50 ⁷⁾	2,00 2,50 ⁷⁾ 3,00 ³⁾⁷⁾	10)	10)
Perforated clay brick HLz; $\rho \geq 0,75$ as per EN 771-1 e.g. Schlagmann S8 Halbziegel LZ, DE  (248/123x365x249) Rotary drilling	5/4	10)	10)	10)	10)	10)	0,30	0,60	10)	10)
	7,5/6	10)	10)	10)	10)	10)	0,40	0,90	10)	10)
	10/8	10)	10)	10)	10)	10)	0,50	1,20	10)	10)
	10,2/-	10)	10)	10)	10)	10)	0,50	1,20	10)	10)
Partial factor	$\gamma_{Mm}^{1)}$ [-]	2,5								

Footnotes see Annex C 16.

fischer frame fixing SXR / SXRL

Performances

Characteristic resistance for use in hollow or perforated masonry

Annex C 32

Appendix 44 / 57

Table C33.1: Characteristic resistance F_{Rk}^{16} in [kN] for use in hollow or perforated brick masonry – base material group “c”

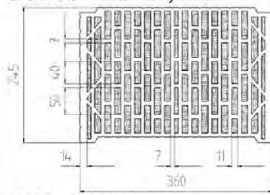
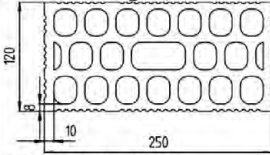
Base material; bulk density [kg/dm ³] [Supplier Title, country] Geometry, DF or nominal Size (L x W x H) [mm] and drilling method	Mean compressive strength as per EN 771 / Minimum compressive strength single brick ¹⁴⁾ [N/mm ²]	Characteristic resistance F_{Rk} [kN] Temperature range 30/50 °C and 50/80 °C								
		SXR 8	SXRL 8 ¹⁵⁾			SXR 10	SXRL 10		SXRL 14	
		h_{nom} [mm]								
		50	50	70	90	50	50	70	70	90
Perforated clay brick HLZ; $\rho \geq 0,8$ as per EN 771-1, e.g. Hörl & Hartmann Coriso WS 09, DE  (245x360x240) Rotary drilling	2,5/2	10)	10)	10)	10)	10)	0,50⁷⁾ 0,60⁴⁾⁷⁾	0,50⁷⁾	10)	10)
	5/4	10)	10)	10)	10)	10)	0,90⁷⁾ 1,20⁴⁾⁷⁾	0,90⁷⁾	10)	10)
	7,5/6	10)	10)	10)	10)	10)	1,50⁷⁾ 2,00⁶⁾⁷⁾	1,50⁷⁾	10)	10)
	7,7/-	10)	10)	10)	10)	10)	1,50⁷⁾ 2,00⁴⁾⁷⁾	1,50⁷⁾	10)	10)
Perforated clay brick HLZ; $\rho \geq 0,9$ as per EN 771-1 e.g. Doppio Uni IT Wienerberger, IT  (250x120x190) Rotary drilling	7,5/6	10)	0,50⁷⁾ 0,60⁸⁾	0,40⁷⁾ 0,60⁸⁾	0,60⁷⁾ 0,75⁸⁾	10)	10)	10)	10)	10)
	10/8	10)	0,60⁷⁾ 0,75⁸⁾	0,60⁷⁾ 0,75⁸⁾	0,75⁷⁾ 0,90⁸⁾	10)	10)	10)	10)	10)
	12,5/10	10)	0,75⁷⁾ 0,90⁸⁾	0,75⁷⁾ 0,90⁸⁾	0,90⁷⁾ 1,20⁸⁾	10)	10)	10)	10)	10)
	15/12	10)	0,90⁷⁾ 1,20⁸⁾	0,90⁷⁾ 1,20⁸⁾	1,20⁷⁾ 1,50⁸⁾	10)	10)	10)	10)	10)
	18,7/-	10)	1,20⁷⁾ 1,50⁸⁾	1,20⁷⁾ 1,50⁸⁾	1,50⁷⁾ 2,00⁸⁾	10)	10)	10)	10)	10)
Partial factor	$\gamma_{Mm}^{1)}$ [-]	2,5								

Footnotes see Annex C 16.

fischer frame fixing SXR / SXRL

Performances

Characteristic resistance for use in hollow or perforated masonry

Annex C 33

Appendix 45 / 57

Table C34.1: Characteristic resistance F_{Rk}^{16} in [kN] for use in hollow or perforated brick masonry – base material group “c”

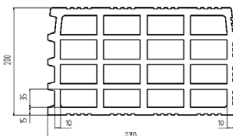
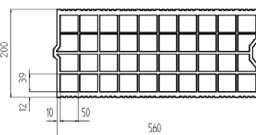
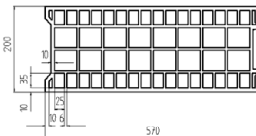
Base material; bulk density [kg/dm ³] [Supplier Title, country] Geometry, DF or nominal Size (L x W x H) [mm] and drilling method	Mean compressive strength as per EN 771 / Minimum compressive strength single brick ¹⁴⁾ [N/mm ²]	Characteristic resistance F_{Rk} [kN] Temperature range 30/50 °C and 50/80 °C								
		SXR 8	SXRL 8		SXR 10	SXRL 10		SXRL 14		
		h _{nom} [mm]								
		50	50	70	90	50	50	70	70	90
Perforated clay brick HLz; $\rho \geq 0,6$ as per EN 771-1, e.g. <i>Imerys Gelimatic, FR</i>  (500x200x270) Rotary drilling	5/4	10)	10)	10)	10)	0,50⁷⁾	10)	1,20⁷⁾	10)	10)
	6,5/-	10)	10)	10)	10)	0,60⁷⁾ 0,75⁸⁾	10)	1,50⁷⁾	10)	10)
Perforated clay brick HLz; $\rho \geq 0,6$ as per EN 771-1, e.g. <i>Imerys Optibric, FR</i>  (560x200x275) Rotary drilling	5/5	10)	10)	10)	10)	0,50⁷⁾ 0,60⁸⁾	10)	0,75⁷⁾	10)	10)
	7,5/6	10)	10)	10)	10)	0,75⁷⁾ 0,90⁸⁾	10)	1,20⁷⁾	10)	10)
	10/8	10)	10)	10)	10)	0,90⁷⁾ 1,20⁸⁾	10)	1,50⁷⁾	10)	10)
	10,5/-	10)	10)	10)	10)	1,20⁷⁾	10)	1,50⁷⁾	10)	10)
Perforated clay brick HLz; $\rho \geq 0,6$ as per EN 771-1, e.g. <i>Bouyer Leroux BGV, FR</i>  (570x200x315) Rotary drilling	5/4	10)	10)	10)	10)	0,60⁷⁾ 0,75⁸⁾	10)	0,75⁷⁾	10)	10)
	7,4/-	10)	10)	10)	10)	0,90⁷⁾ 1,20⁸⁾	10)	1,20⁷⁾	10)	10)
Partial factor	$\gamma_{Mm}^{1)}$ [-]	2,5								

Footnotes see Annex C 16.

fischer frame fixing SXR / SXRL

Performances

Characteristic resistance for use in hollow or perforated masonry

Annex C 34

Appendix 46 / 57

Table C35.1: Characteristic resistance $F_{Rk}^{16)}$ in [kN] for use in hollow or perforated brick masonry – base material group “c”

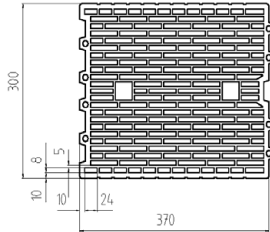
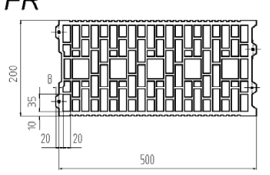
Base material; bulk density [kg/dm ³] [Supplier Title, country] Geometry, DF or nominal Size (L x W x H) [mm] and drilling method	Mean compressive strength as per EN 771 / Minimum compressive strength single brick ¹⁴⁾ [N/mm ²]	Characteristic resistance F_{Rk} [kN] Temperature range 30/50 °C and 50/80 °C								
		SXR 8	SXRL 8		SXR 10	SXRL 10		SXRL 14		
		h_{nom} [mm]								
		50	50	70	90	50	50	70	70	90
Perforated clay brick HLz; $\rho \geq 0,7$ as per EN 771-1, e.g. Wienerberger Porotherm 30 R, FR 	7,5/6	10)	10)	10)	10)	0,40 ⁷⁾	10)	10)	10)	10)
	10/8	10)	10)	10)	10)	0,50 ⁷⁾ 0,60 ⁸⁾	10)	10)	10)	10)
	10,7/-	10)	10)	10)	10)	0,50 ⁷⁾ 0,60 ⁸⁾	10)	10)	10)	10)
Perforated clay brick HLz; $\rho \geq 0,7$ as per EN 771-1 e.g. Wienerberger Porotherm GF R20, FR 	5/4	10)	10)	10)	10)	10)	10)	0,40 ⁷⁾ 0,50 ⁸⁾	10)	10)
	7,5/6	10)	10)	10)	10)	0,40 0,50 ²⁾	10)	0,60 ⁷⁾ 0,75 ⁸⁾	10)	10)
	10/8	10)	10)	10)	10)	0,60	10)	0,90 ⁸⁾	10)	10)
	11,8/-	10)	10)	10)	10)	0,60 0,75 ²⁾	10)	0,90 ⁷⁾ 1,20 ⁸⁾	10)	10)
Partial factor	$\gamma_{Mm}^{1)}$ [-]	2,5								

Footnotes see Annex C 16.

fischer frame fixing SXR / SXRL

Performances

Characteristic resistance for use in hollow or perforated masonry

Annex C 35

Appendix 47 / 57

Table C36.1: Characteristic resistance $F_{Rk}^{16)}$ in [kN] for use in hollow or perforated brick masonry – base material group “c”

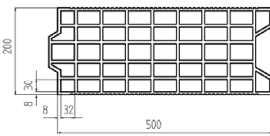
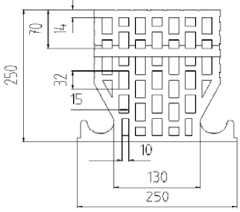
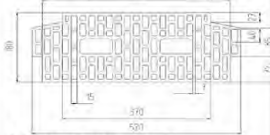
Base material; bulk density [kg/dm ³] [Supplier Title, country] Geometry, DF or nominal Size (L x W x H) [mm] and drilling method	Mean compressive strength as per EN 771 / Minimum compressive strength single brick ¹⁴⁾ [N/mm ²]	Characteristic resistance F_{Rk} [kN] Temperature range 30/50 °C and 50/80 °C								
		SXR 8	SXRL 8		SXR 10	SXRL 10		SXRL 14		
		h _{nom} [mm]								
		50	50	70	90	50	50	70	70	90
Perforated clay brick HLz; $\rho \geq 0,7$ as per EN 771-1, e.g. <i>Terreal Calibric, FR</i>  (500x200x220) Rotary drilling	5/4	10)	10)	10)	10)	0,30 0,40 ²⁾	10)	0,60 ⁷⁾	10)	10)
	7,5/6	10)	10)	10)	10)	0,50 0,60 ²⁾	10)	0,90 ⁷⁾	10)	10)
	9,4/-	10)	10)	10)	10)	0,60 0,75 ²⁾	10)	0,90 ⁷⁾ 1,20 ⁸⁾	10)	10)
Perforated clay ceiling brick; $\rho \geq 0,7$ as per EN 15037-3 e.g. <i>Hörl & Hartmann ceiling block, DE</i>  (250x250x190) Rotary drilling	5/4	10)	10)	10)	10)	10)	10)	0,90 ⁷⁾	10)	10)
	7,5/6	10)	10)	10)	10)	10)	10)	1,50 ⁷⁾	10)	10)
	10/8	10)	10)	10)	10)	10)	10)	2,00 ⁷⁾	10)	10)
	12,1/-	10)	10)	10)	10)	10)	10)	2,50 ⁷⁾	10)	10)
Perforated clay ceiling brick; $\rho \geq 0,7$ as per EN 15037 e.g. <i>Hörl & Hartmann block for beam-and-block ceilings, DE</i>  (520x250x180) Rotary drilling	2,5/2	10)	10)	10)	10)	10)	10)	0,50 ⁷⁾	10)	10)
	5/4	10)	10)	10)	10)	10)	10)	0,90 ⁷⁾ 1,20 ⁸⁾	10)	10)
	7,5/6	10)	10)	10)	10)	10)	10)	1,50 ⁷⁾	10)	10)
	8,9/-	10)	10)	10)	10)	10)	10)	2,00 ⁷⁾	10)	10)
Partial factor	$\gamma_{Mm}^{1)}$ [-]	2,5								

Footnotes see Annex C 16.

fischer frame fixing SXR / SXRL

Performances

Characteristic resistance for use in hollow or perforated masonry

Annex C 36

Appendix 48 / 57

Table C37.1: Characteristic resistance $F_{Rk}^{16)}$ in [kN] for use in hollow or perforated brick masonry – base material group “c”

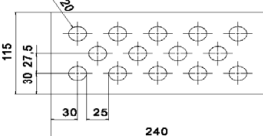
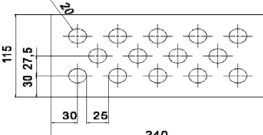
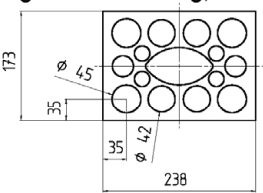
Base material; bulk density [kg/dm ³] [Supplier Title, country] Geometry, DF or nominal Size (L x W x H) [mm] and drilling method	Mean compressive strength as per EN 771 / Minimum compressive strength single brick ¹⁴⁾ [N/mm ²]	Characteristic resistance F_{Rk} [kN] Temperature range 30/50 °C and 50/80 °C								
		SXR 8	SXRL 8 ¹⁵⁾			SXR 10	SXRL 10		SXRL 14 ¹⁵⁾	
		h _{nom} [mm]								
		50	50	70	90	50	50	70	70	90
Hollow calcium silicate brick KSL; $\rho \geq 1,4$ as per EN 771-2 e.g. KS Wemding, DE 	7,5/6	0,75 ⁷⁾ 0,90 ⁸⁾	10)	10)	10)	0,90 ⁷⁾	10)	1,50 ⁷⁾	1,20	2,50
	10/8	0,90 ⁷⁾ 1,20 ⁸⁾	10)	10)	10)	1,20 ⁷⁾ 1,50 ⁸⁾	10)	2,00 ⁷⁾	1,50	2,50
	12,5/10	1,20 ⁷⁾ 1,50 ⁸⁾	10)	10)	10)	1,50 ⁷⁾	10)	2,50 ⁷⁾	2,00	2,50
	15/12	1,50 ⁷⁾ 2,00 ⁸⁾	10)	10)	10)	2,00 ⁷⁾	10)	2,50 ⁷⁾	2,00 2,50 ²⁾	2,50
	17,6/-	2,00 ⁷⁾	10)	10)	10)	2,00 ⁷⁾ 2,50 ⁸⁾	10)	2,50 ⁷⁾	2,50	2,50
Hollow calcium silicate brick KSL; $\rho \geq 1,6$ as per EN 771-2 e.g. KS Wemding, DE 	10/8	10)	0,60 0,75 ²⁾	0,90 1,20 ²⁾	0,75 ⁷⁾ 0,90 ⁸⁾	10)	10)	10)	10)	10)
	12,5/10	10)	0,75 0,90 ²⁾	1,20 1,50 ²⁾	0,90 ⁷⁾ 1,20 ⁸⁾	10)	10)	10)	10)	10)
	15/12	10)	0,90	1,50 2,00 ²⁾	1,20 ⁷⁾ 1,50 ⁸⁾	10)	10)	10)	10)	10)
	20/16	10)	1,20 1,50 ²⁾	2,00 2,50 ²⁾	1,50 ⁷⁾ 2,00 ⁸⁾	10)	10)	10)	10)	10)
	25/20	10)	1,50	2,50	2,00 ⁷⁾ 2,50 ⁸⁾	10)	10)	10)	10)	10)
	32,5/-	10)	2,00	2,50	2,50 ⁷⁾	10)	10)	10)	10)	10)
Hollow calcium silicate brick KSL; $\rho \geq 1,4$ as per EN 771-2 e.g. KS Wemding, DE 	7,5/6	10)	10)	10)	10)	0,60 ⁷⁾ 0,75 ⁸⁾	10)	0,60	10)	10)
	10/8	0,50 ⁷⁾	10)	10)	10)	0,90 ⁷⁾	10)	0,75	10)	10)
	12,5/10	0,60 ⁷⁾	10)	10)	10)	1,20 ⁷⁾	10)	0,90	10)	10)
	15/12	0,75 ⁷⁾	10)	10)	10)	1,20 ⁷⁾ 1,50 ⁸⁾	10)	1,20	10)	10)
	20/16	0,90 ⁷⁾ 1,20 ⁸⁾	10)	10)	10)	1,50 ⁷⁾ 2,00 ⁸⁾	10)	1,50	10)	10)
	25/20	1,20 ⁷⁾	10)	10)	10)	10)	10)	2,00	10)	10)
	27,7/-	1,20 ⁷⁾ 1,50 ⁸⁾	10)	10)	10)	10)	10)	2,00	10)	10)
Partial factor	$\gamma_{Mm}^{1)}$ [-]	2,5								

Footnotes see Annex C 16.

fischer frame fixing SXR / SXRL

Performances

Characteristic resistance for use in hollow or perforated masonry

Annex C 37

Appendix 49 / 57

Table C38.1: Characteristic resistance F_{Rk}^{16} in [kN] for use in hollow or perforated brick masonry – base material group “c”

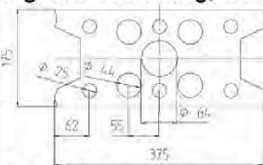
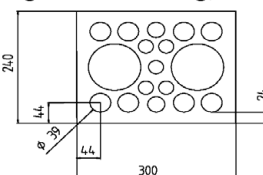
Base material; bulk density [kg/dm ³] [Supplier Title, country] Geometry, DF or nominal Size (L x W x H) [mm] and drilling method	Mean compressive strength as per EN 771 / Minimum compressive strength single brick ¹⁴⁾ [N/mm ²]	Characteristic resistance F_{Rk} [kN] Temperature range 30/50 °C and 50/80 °C								
		SXR 8	SXRL 8 ¹⁵⁾			SXR 10	SXRL 10		SXRL 14 ¹⁵⁾	
		h _{nom} [mm]								
		50	50	70	90	50	50	70	70	90
Hollow calcium silicate brick KSL; $\rho \geq 1,4$ as per EN 771-2 e.g. KS Wemding, DE  9 DF (375x175x248) Hammer drilling	10/8	10)	0,30 ⁷⁾	0,60 ⁷⁾ 0,75 ⁸⁾	0,30 ⁷⁾ 0,40 ⁸⁾	10)	10)	1,50 ⁷⁾	1,50 ⁷⁾ 2,00 ⁸⁾	0,75 ⁷⁾ 0,90 ⁸⁾
	12,5/10	10)	0,30 ⁷⁾ 0,40 ⁸⁾	0,75 ⁷⁾ 0,90 ⁸⁾	0,40 ⁷⁾ 0,60 ⁸⁾	10)	10)	1,50 ⁷⁾ 2,0 ⁸⁾	2,00 ⁷⁾	0,90 ⁷⁾ 1,20 ⁸⁾
	15/12	10)	0,40 ⁷⁾	0,90 ⁷⁾ 1,20 ⁸⁾	0,50 ⁷⁾ 0,60 ⁸⁾	10)	10)	2,00 ⁷⁾	2,50 ⁷⁾	1,20 ⁷⁾ 1,50 ⁸⁾
	20/16	10)	0,50 ⁷⁾ 0,60 ⁸⁾	1,20 ⁷⁾ 1,50 ⁸⁾	0,75 ⁷⁾ 0,90 ⁸⁾	10)	10)	3,00 ⁷⁾	3,00 ⁷⁾ 3,50 ⁸⁾	1,50 ⁷⁾ 2,00 ⁸⁾
	25/20	10)	0,60 ⁷⁾ 0,75 ⁸⁾	1,50 ⁷⁾ 2,00 ⁸⁾	0,90 ⁷⁾ 1,20 ⁸⁾	10)	10)	3,50 ⁷⁾	4,00 ⁷⁾ 4,50 ⁸⁾	2,00 ⁷⁾ 2,50 ⁸⁾
	28,5/-	10)	0,60 ⁷⁾ 0,75 ⁸⁾	1,50 ⁷⁾ 2,00 ⁸⁾	0,90 ⁷⁾ 1,20 ⁸⁾	10)	10)	4,00 ⁷⁾	4,50 ⁷⁾ 5,00 ⁸⁾	2,00 ⁷⁾ 2,50 ⁸⁾
Hollow calcium silicate brick KSL; $\rho \geq 1,4$ as per EN 771-2 e.g. KS Wemding, DE  5 DF (300x240x113) Hammer drilling	7,5/6	0,40 ⁷⁾ 0,50 ⁸⁾	10)	10)	10)	1,20 ⁷⁾	10)	10)	10)	10)
	10/8	0,50 ⁷⁾ 0,60 ⁸⁾	10)	10)	10)	1,50 ⁷⁾	10)	10)	10)	10)
	12,5/10	0,60 ⁷⁾ 0,75 ⁸⁾	10)	10)	10)	2,00 ⁷⁾	10)	10)	10)	10)
	15/12	0,75 ⁷⁾ 0,90 ⁸⁾	10)	10)	10)	2,00 ⁷⁾ 2,50 ⁸⁾	10)	10)	10)	10)
	20/16	0,90 ⁷⁾ 1,20 ⁸⁾	10)	10)	10)	2,50 ⁷⁾	10)	10)	10)	10)
	25/20	1,20 ⁷⁾ 1,50 ⁸⁾	10)	10)	10)	2,50 ⁷⁾	10)	10)	10)	10)
	35/28	2,00 ⁷⁾	10)	10)	10)	2,50 ⁷⁾	10)	10)	10)	10)
	36,4/-	2,00 ⁷⁾	10)	10)	10)	2,50 ⁷⁾	10)	10)	10)	10)
Partial factor $\gamma_{Mm}^{1)}$ [-]	2,5									

Footnotes see Annex C 16.

fischer frame fixing SXR / SXRL

Performances

Characteristic resistance for use in hollow or perforated masonry

Annex C 38

Appendix 50 / 57

Table C39.1: Characteristic resistance $F_{Rk}^{16)}$ in [kN] for use in hollow or perforated brick masonry – base material group “c”

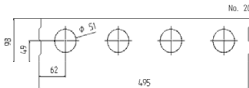
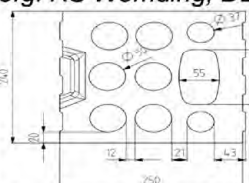
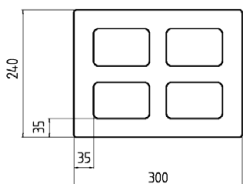
Base material; bulk density [kg/dm ³] [Supplier Title, country] Geometry, DF or nominal Size (L x W x H) [mm] and drilling method	Mean compressive strength as per EN 771 / Minimum compressive strength single brick ¹⁴⁾ [N/mm ²]	Characteristic resistance F_{Rk} [kN] Temperature range 30/50 °C and 50/80 °C								
		SXR 8	SXRL 8		SXR 10	SXRL 10		SXRL 14		
		h _{nom} [mm]								
		50	50	70	90	50	50	70	70	90
Hollow calcium silicate brick KSL; $\rho \geq 1,2$ as per EN 771-2 e.g. <i>KS Wemding, P10, DE</i>  (495x98x245) Hammer drilling	2,5/2	0,30 0,40 ²⁾	10)	10)	10)	0,60 0,75 ²⁾	10)	10)	10)	10)
	5/4	0,60 0,75 ²⁾	10)	10)	10)	1,20 1,50 ²⁾	10)	10)	10)	10)
	7,5/6	0,90 1,20 ²⁾	10)	10)	10)	2,00 2,50 ²⁾	10)	10)	10)	10)
	9,4/-	1,20 1,50 ²⁾	10)	10)	10)	2,00 2,50 ²⁾	10)	10)	10)	10)
Hollow calcium silicate brick KSL; $\rho \geq 1,4$ as per EN 771-2 e.g. <i>KS Wemding, DE</i>  9 DF (250x240x240) Hammer drilling	7,5/6	10)	10)	10)	10)	10)	10)	0,90 ⁷⁾ 1,20 ⁸⁾	10)	10)
	10/8	10)	10)	10)	10)	10)	10)	1,50 ⁷⁾	10)	10)
	12,5/10	10)	10)	10)	10)	10)	10)	1,50 ⁷⁾ 2,00 ⁸⁾	10)	10)
	15/12	10)	10)	10)	10)	10)	10)	2,00 ⁷⁾	10)	10)
	16,5/-	10)	10)	10)	10)	10)	10)	2,50 ⁷⁾	10)	10)
Hollow brick light-weight concrete Hbl; $\rho \geq 1,4$ as per EN 771-3, e.g. <i>KLB, DE</i>  (300x240x240) Hammer drilling	2,5/2	10)	10)	10)	10)	1,50 ⁷⁾ 2,00 ⁸⁾	10)	10)	10)	10)
	2,6/-	10)	10)	10)	10)	2,00 ⁷⁾	10)	10)	10)	10)
Partial factor	$\gamma_{Mm}^{1)}$ [-]	2,5								

Footnotes see Annex C 16.

fischer frame fixing SXR / SXRL



Performances

Characteristic resistance for use in hollow or perforated masonry

Annex C 39

Appendix 51 / 57

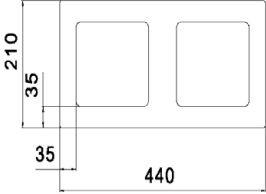
Table C40.1: Characteristic resistance F_{Rk}^{16} in [kN] for use in hollow or perforated brick masonry – base material group “c”

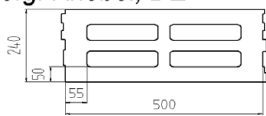
Base material; bulk density [kg/dm ³] [Supplier Title, country] Geometry, DF or nominal Size (L x W x H) [mm] and drilling method	Mean compressive strength as per EN 771 / Minimum compressive strength single brick ¹⁴⁾ [N/mm ²]	Characteristic resistance F_{Rk} [kN] Temperature range 30/50 °C and 50/80 °C								
		SXR 8	SXRL 8 ¹⁵⁾			SXR 10	SXRL 10		SXRL 14 ¹⁵⁾	
		h_{nom} [mm]								
		50	50	70	90	50	50	70	70	90
Hollow brick light-weight concrete Hbl; $\rho \geq 1,2$ as per EN 771-3, e.g. <i>Roadstone masonry, IE</i>  (440x210x215) Hammer drilling	2,5/2	0,75 ⁷⁾ 0,90 ⁸⁾	0,40 ⁷⁾ 0,50 ⁸⁾	0,40 ⁷⁾ 0,50 ⁸⁾	10)	0,90 ⁷⁾ 1,20 ⁸⁾	10)	0,60 ⁷⁾	0,90 ⁷⁾	10)
	5/4	1,50 ⁷⁾ 2,00 ⁸⁾	0,90 ⁷⁾	0,75 ⁷⁾ 0,90 ⁸⁾	0,30 ⁸⁾	2,00 ⁷⁾	10)	1,20 ⁷⁾	2,00 ⁷⁾	10)
	7,5/6	2,50 ⁷⁾	1,20 ⁷⁾ 1,50 ⁸⁾	1,20 ⁷⁾ 1,50 ⁸⁾	0,30 ⁷⁾ 0,40 ⁸⁾	2,50 ⁷⁾	10)	2,00 ⁷⁾	2,50 ⁷⁾	10)
	10/8	2,50 ⁷⁾	1,50 ⁷⁾ 2,00 ⁸⁾	1,50 ⁷⁾ 2,00 ⁸⁾	0,40 ⁷⁾ 0,50 ⁸⁾	2,50 ⁷⁾	10)	2,50 ⁷⁾	3,50 ⁷⁾	10)
	11,3/-	2,50 ⁷⁾	2,00 ⁷⁾	2,00 ⁷⁾ 2,50 ⁸⁾	0,40 ⁷⁾ 0,60 ⁸⁾	2,50 ⁷⁾	10)	2,50 ⁷⁾	4,00 ⁷⁾	10)
Hollow brick light-weight concrete Hbl; $\rho \geq 0,8$ as per EN 771-3, e.g. <i>Knobel, DE</i>  (500x240x240) Rotary drilling	2,5/2	10)	1,20 ⁷⁾	1,20 ⁷⁾ 1,50 ⁸⁾	1,20 ⁷⁾	10)	1,20 ⁷⁾ 1,50 ⁸⁾	1,50 ⁷⁾ 2,00 ⁴⁾⁸⁾	2,00 ⁷⁾	1,50 ⁷⁾
	4,0/-	10)	1,50 ⁷⁾ 2,00 ⁸⁾	2,00 ⁷⁾ 2,50 ⁸⁾	1,50 ⁷⁾ 2,00 ⁸⁾	10)	2,00 ⁷⁾ 2,50 ⁸⁾	2,50 ⁷⁾ 3,00 ⁴⁾⁸⁾ 3,50 ⁶⁾⁸⁾	2,50 ⁷⁾	2,50 ⁷⁾
Hollow brick light-weight concrete Hbl; $\rho \geq 0,9$ as per EN 771-3, e.g. <i>Knobel, DE</i>  (500x240x240) Rotary drilling	2,5/2	10)	0,60 ⁷⁾	0,90 ⁷⁾ 1,50 ⁸⁾	0,60 ⁷⁾ 0,75 ⁸⁾	10)	0,90 ⁷⁾	10)	10)	10)
	5/4	10)	1,20 ⁷⁾	2,00 ⁷⁾ 2,50 ⁸⁾	1,20 ⁷⁾ 1,50 ⁸⁾	10)	2,00 ⁷⁾	10)	10)	10)
	6,2/-	10)	1,50 ⁷⁾	2,50 ⁷⁾	1,50 ⁷⁾ 2,00 ⁸⁾	10)	2,50 ⁷⁾	10)	10)	10)
Partial factor	$\gamma_{Mm}^{1)}$ [-]	2,5								

Footnotes see Annex C 16.

fischer frame fixing SXR / SXRL

Performances

Characteristic resistance for use in hollow or perforated masonry

Annex C 40

Appendix 52 / 57

Table C41.1: Characteristic resistance F_{Rk}^{16} in [kN] for use in hollow or perforated brick masonry – base material group “c”

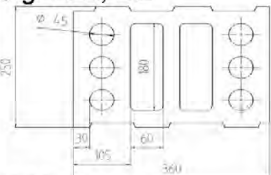
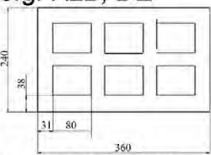
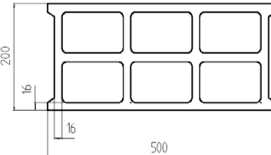
Base material; bulk density [kg/dm ³] [Supplier Title, country] Geometry, DF or nominal Size (L x W x H) [mm] and drilling method	Mean compressive strength as per EN 771 / Minimum compressive strength single brick ¹⁴⁾ [N/mm ²]	Characteristic resistance F_{Rk} [kN] Temperature range 30/50 °C and 50/80 °C								
		SXR 8		SXRL 8		SXR 10		SXRL 10		SXRL 14
		h _{nom} [mm]								
		50	50	70	90	50	50	70	70	90
Hollow brick light-weight concrete Hbl; $\rho \geq 0,9$ as per EN 771-3, e.g. <i>KLB, DE</i> 	2,5/2	10)	10)	10)	10)	10)	10)	1,20 ⁷⁾	10)	10)
	3,9/-	10)	10)	10)	10)	10)	10)	2,00 ⁷⁾	10)	10)
Hollow brick light-weight concrete Hbl; $\rho \geq 1,0$ as per EN 771-3, e.g. <i>KLB, DE</i> 	2,5/2	0,50 ⁷⁾ 0,60 ⁸⁾	10)	10)	10)	10)	10)	10)	10)	10)
	5/4	1,20 ⁷⁾	10)	10)	10)	10)	10)	10)	10)	10)
	6,3/-	1,20 ⁷⁾ 1,50 ⁸⁾	10)	10)	10)	10)	10)	10)	10)	10)
Hollow brick light-weight concrete Hbl; $\rho \geq 0,9$ as per EN 771-3, e.g. <i>Sepa Parpaing, FR</i> 	2,5/2	10)	10)	10)	10)	0,30 0,60 ⁷⁾	10)	10)	10)	10)
	5/4	0,30	10)	10)	10)	0,60 1,20 ⁷⁾	10)	0,30 ⁷⁾ 0,40 ⁸⁾	10)	10)
	5,9/-	0,30 0,40 ²⁾	10)	10)	10)	0,75 1,20 ⁷⁾ 1,50 ⁸⁾	10)	0,40 ⁷⁾ 0,50 ⁸⁾	10)	10)
	7,5/6	0,30 0,40 ²⁾	10)	10)	10)	0,75 1,20 ⁷⁾ 1,50 ⁸⁾	10)	0,50 ⁷⁾ 0,60 ⁸⁾	10)	10)
	8,4/-	0,30 0,40 ²⁾	10)	10)	10)	0,75 1,20 ⁷⁾ 1,50 ⁸⁾	10)	0,60 ⁷⁾	10)	10)
Partial factor	$\gamma_{Mm}^{1)}$ [-]	2,5								

Footnotes see Annex C 16.

fischer frame fixing SXR / SXRL

Performances

Characteristic resistance for use in hollow or perforated masonry

Annex C 41

Appendix 53 / 57

Table C42.1: Characteristic resistance $F_{Rk}^{16)}$ in [kN] for use in hollow or perforated brick masonry – base material group “c”

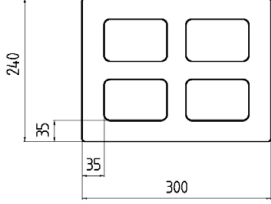
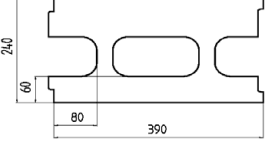
Base material; bulk density [kg/dm ³] [Supplier Title, country] Geometry, DF or nominal Size (L x W x H) [mm] and drilling method	Mean compressive strength as per EN 771 / Minimum compressive strength single brick ¹⁴⁾ [N/mm ²]	Characteristic resistance F_{Rk} [kN] Temperature range 30/50 °C and 50/80 °C								
		SXR 8	SXRL 8		SXR 10	SXRL 10		SXRL 14		
		h _{nom} [mm]								
		50	50	70	90	50	50	70	70	90
Hollow brick normal concrete Hbn; $\rho \geq 1,6$ as per EN 771-3, e.g. <i>Adolf Blatt, DE</i> 	2,5/2	10)	10)	10)	10)	1,50 ⁷⁾	10)	0,75 ⁷⁾ 1,50 ⁴⁾⁷⁾	10)	10)
	5/4	10)	10)	10)	10)	2,50 ⁷⁾	10)	1,50 ⁷⁾ 2,50 ⁴⁾⁷⁾	10)	10)
	7,3/-	10)	10)	10)	10)	2,50 ⁷⁾	10)	2,00 ⁷⁾ 2,50 ⁴⁾⁷⁾	10)	10)
Heat insulation brick WDB; $\rho \geq 0,7$ e.g. <i>Gisoton, DE</i> 	2,5/2	10)	10)	10)	10)	1,50 ⁷⁾	10)	10)	10)	10)
	3,7/-	10)	10)	10)	10)	2,00 ⁷⁾ 2,50 ⁸⁾	10)	10)	10)	10)
Partial factor $\gamma_{Mm}^{1)}$ [-]		2,5								

Footnotes see Annex C 16.

fischer frame fixing SXR / SXRL

Performances

Characteristic resistance for use in hollow or perforated masonry

Annex C 42

Appendix 54 / 57

Table C43.1: Characteristic resistance $F_{Rk}^{16)}$ in [kN] in perforated bricks for use in the header side – base material group “c”

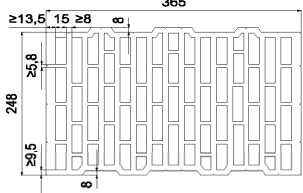
Base material; bulk density [kg/dm ³] [Supplier Title, country] Geometry, DF or nominal Size (L x W x H) [mm] and drilling method	Brick drawing [mm]	Mean compressive strength as per EN 771 / Minimum compressive strength single brick ¹⁴⁾ [N/mm ²]	SXRL 10 Characteristic resistance F_{Rk} [kN] Temperature range 30/50°C and 50/80°C	
			h_{nom} [mm]	
			70	90
Perforated clay brick HLz; $\rho \geq 0,75$ as per EN 771-1 e.g. Schlagmann Poroton S9, DE (248x365x249) Rotary drilling		7,5/6	0,75	0,75
		10/8	0,90	0,90
		12,5/10	1,20	1,20
		15/12	1,50	1,50
		16/-	1,50	1,50
Partial factor		$\gamma_{Mm}^{1)}$ [-]	2,5	
Minimum edge distance	$c_{min} =$ [mm]		70	
Minimum spacing perpendicular to free edge	$s_{1,min} =$ [mm]		140	
Minimum spacing parallel to free edge	$s_{2,min} =$ [mm]		250	

Footnotes see Annex C 16.

Table C43.2: Characteristic resistance $F_{Rk}^{16)}$ in [kN] in perforated bricks for use in the header side – base material group “c”

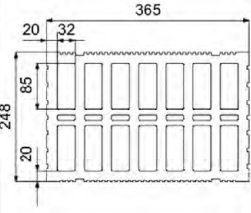
Base material; bulk density [kg/dm ³] [Supplier Title, country] Geometry, DF or nominal Size (L x W x H) [mm] and drilling method	Brick drawing [mm]	Mean compressive strength as per EN 771 / Minimum compressive strength single brick ¹⁴⁾ [N/mm ²]	SXRL 10 Characteristic resistance F_{Rk} [kN] Temperature range 30/50°C and 50/80°C			
			h_{nom} [mm]			
			70	90	150 ¹³⁾	180 ¹³⁾
Perforated clay brick HLz; $\rho \geq 0,75$ as per EN 771-1 e.g. Schlagmann S8 Halbziegel LZ, DE (248/123 x 365 x 249) Rotary drilling		5/4	0,50 ¹²⁾	0,30 0,60 ¹²⁾	0,90	0,30 0,60 ¹²⁾
		7,5/6	0,30 0,75 ¹²⁾	0,40 0,90 ¹²⁾	1,20	0,50 0,90 ¹²⁾
		10/8	0,40 1,20 ¹²⁾	0,50 1,20 ¹²⁾	1,50	0,60 1,20 ¹²⁾
		10,2/-	0,40 1,20 ¹²⁾	0,60 1,20 ¹²⁾	1,50	0,60 1,20 ¹²⁾
Partial factor		$\gamma_{Mm}^{1)}$ [-]	2,5			
Minimum edge distance	$c_{min} =$ [mm]		75			
Minimum spacing perpendicular to free edge	$s_{1,min} =$ [mm]		150			
Minimum spacing parallel to free edge	$s_{2,min} =$ [mm]		250			

Footnotes see Annex C 16.

fischer frame fixing SXR / SXRL

Performances

Characteristic resistance for use in perforated bricks – for use in the header side

Annex C 43

Appendix 55 / 57

Table C44.1: Characteristic resistance F_{Rk} in [kN] for use in unreinforced autoclaved aerated concrete – base material group “d”

Base material Size (L x W x H) [mm] and drilling method	Mean compressive strength as per EN 771-4 $f_{cm,decl}$ [N/mm ²]	Characteristic resistance F_{Rk} [kN] Temperature range 30/50 °C and 50/80 °C								
		SXR 8	SXRL 8		SXR 10	SXRL 10 ³⁾		SXRL 14		
		h_{nom} [mm]								
		≥ 50	≥ 50	≥ 70	≥ 90	≥ 50	≥ 70	≥ 90	≥ 70	≥ 90
Autoclaved aerated concrete as per EN 771-4 e.g. (500x120x300) e.g. (500x250x300) Hammer drilling	≥ 2,0	8)	8)	0,40	0,60	0,40 ³⁾ 0,50 ²⁾³⁾	0,50	0,60 ⁷⁾ 0,90 ⁴⁾⁵⁾	0,90	1,20
	≥ 2,5	8)	8)	8)	8)	8)	0,75	0,90 ⁷⁾ 1,20 ⁴⁾⁵⁾	8)	8)
	≥ 3,0	8)	8)	0,60 0,90 ⁶⁾	0,90 1,20 ⁶⁾	0,40 ³⁾ 0,50 ²⁾³⁾	0,90 1,20 ⁴⁾	1,20 ⁷⁾ 1,50 ⁴⁾⁵⁾	1,50	2,00
	≥ 3,5	8)	8)	8)	8)	8)	1,20 1,50 ⁴⁾	1,50 ⁷⁾ 2,00 ⁴⁾⁵⁾	8)	8)
	≥ 4,0	8)	8)	0,90 1,50 ⁶⁾	1,20 1,50 ⁶⁾	0,75 0,90 ²⁾	1,50 2,00 ⁴⁾	1,50 ⁷⁾ 2,00 ⁴⁾	2,50	3,00
	≥ 4,5	8)	8)	8)	8)	8)	1,50 2,00 ⁴⁾	2,00 ⁷⁾ 2,50 ⁴⁾⁷⁾	8)	8)
	≥ 5,0	8)	8)	8)	8)	8)	2,00 2,50 ⁴⁾	2,00 ⁷⁾ 3,00 ⁴⁾	8)	8)
	≥ 6,0	8)	8)	1,50 3,00 ⁶⁾	2,00 3,00 ⁶⁾	0,75 0,90 ⁶⁾	2,50 3,00 ⁴⁾	3,00 ⁷⁾ 3,50 ⁴⁾⁷⁾	4,00	5,00
Partial factor	$\gamma_{MAAC}^{1)}$ [-]	2,0								

1) In absence of other national regulations.

2) Only valid for temperature range 30/50° C.

3) The characteristic resistance F_{Rk} for SXRL 10 also valid for installation in the stretcher and in the header side of the blocks.

4) Values valid for member thickness $h_{min} \geq 175$ mm.

5) Only valid for edge distance $c_{1,min} \geq 100$ mm and $c_{2,min} \geq 150$ mm.

6) Only valid for edge distance $c_{1,min} \geq 120$ mm $c_{2,min} \geq 180$ mm.

7) Only valid for spacing $s_{1,min} \geq 240$ mm and $s_{2,min} \geq 250$ mm

8) No performance assessed.

fischer frame fixing SXR / SXRL

Performances

Characteristic resistance for use in unreinforced autoclaved aerated concrete

Annex C 44

Appendix 56 / 57

Table C45.1: Characteristic resistance F_{Rk} in [kN] for use in reinforced autoclaved aerated concrete for SXRL 10 – base material group “d”

Base material and drilling method	Compressive strength f_{ck} [N/mm ²] (compressive strength class) as per EN 12602	Characteristic resistance F_{Rk} [kN] Temperature range 30/50 °C and 50/80 °C			
		$h_{nom} \geq 70$ mm		$h_{nom} \geq 90$ mm	
		Member thickness h_{min} [mm]			
		175	240	175	240
Reinforced autoclaved aerated concrete, AAC as per EN 12602 Hammer drilling	$\geq 2,0$ (AAC 2)	0,50	2)	0,50	2)
	$\geq 2,5$ (AAC 2,5)	0,75	2)	0,90	2)
	$\geq 3,0$ (AAC 3)	1,20	2)	1,20	2)
	$\geq 3,5$ (AAC 3,5)	1,50	2)	1,50	2)
	$\geq 4,0$ (AAC 4)	3)	1,50	3)	2,00
	$\geq 4,5$ (AAC 4,5)	3)	2,00	3)	2,50
	$\geq 5,0$ (AAC 5)	3)	2,00	3)	2,50
	$\geq 6,0$ (AAC 6)	3)	3,00	3)	3,50
Partial factor	$\gamma_{MAAC}^{1)}$ [-]	2,0			

1) In absence of other national regulations.

2) The characteristic resistance F_{Rk} at h_{min} 175 mm is also valid for bigger member thickness.

3) No performance assessed.

fischer frame fixing SXR / SXRL

Performances

Characteristic resistance for use in reinforced autoclaved aerated concrete

Annex C 45

Appendix 57 / 57