

**EN 131-1 + EN 131-2 + EN 131-3
Ladders and Stand Ladders**

Report Reference No......: 20-056221230

Total Number of pages.....: 41

Date of issue: 2022-12-30

Tested by: Olga do Vale

Approved by (name + signature).....: Manuel Farias

Olga do Vale
Manuel Farias

Testing Laboratory.....: LIQ – Laboratório Industrial da Qualidade, ATC

Address.....: Zona Industrial da Alagoa, Rua do Portinho, No. 1431
3750- 901 Águeda Portugal

Applicant's name: José Luís & cia, Lda.

Address.....: Zona Industrial Sul; Apartado 70
3886-908 CORTEGAÇA OVAR

Manufacturer: José Luís & cia, Lda.

Address.....: Zona Industrial Sul; Apartado 70
3886-908 CORTEGAÇA OVAR

Standard.....: EN 131-1:2015 + A1: 2019

EN 131-2:2010 + A2:2017

EN 131-3:2018

Tested appliance: Standing step ladder

Trade Mark.....: FERRAL

Model/Type reference: CLASSIK

Ratings.....: 8 Steps with anti-opening straps; Rung: 80 x 1,2 mm (minimum); Support profile: 33 x 20 x 1,3 mm; Access profile: 50 x 20 x 1,3 mm; Support tube: 18 X 1,3 mm.

Observations.....:

Variant: 7, 6 and steps with anti-opening straps, 4, 3 and 2 steps with no anti-opening straps.

Possible test case verdicts:

- The case does not apply to the test object : N/A
- Test object does meet the requirement : P
- Test object does not meet the requirement : F
- Clause not verified :---

General remarks:

(1) The test results presented in this report relate only to the object tested. (2) This report shall not be reproduced, except in full, without the written approval of the Issuing testing laboratory. (3) "(See appended table) (4) " refers to a table appended to the report. (5) "(See remark #)" refers to a remark appended to the report. (6) "(####)" refers to the internal code of testing equipment.

Testing

Date of receipt of test item: 2020-03-18

Date of begin of test item:2020-03-25

Date of end of test item:2020-03-31

EN 131-1 + EN 131-2 + EN 131-3			
Clause	Requirement + Test	Result - Remark	Verdict
EN 131-1			
4	FUNCTIONAL SIZES		
4.1	The rungs and steps of a ladder shall be equally spaced with a tolerance of ± 2 mm.	< 2 mm	P
4.2	Leaning rung ladders		
	Type		N/A
	Functional sizes	(see appended table)	N/A
4.3	Standing rung ladders		
	The legs are connected with hinge joints and shall be secured from sliding apart.		N/A
	Functional sizes	(see appended table)	N/A
4.4	Combination ladders		
	When combination ladders are used as standing ladders, the ladder parts shall be secured from sliding apart.		N/A
	Type		N/A
	Functional sizes	(see appended table)	N/A
4.5	Leaning step ladders		
	The permissible inclination α applies to the height of the touch-down surface above floor level, when the steps are in horizontal position.	$\alpha = \text{_____}^\circ$	N/A
	Functional sizes	(see appended table)	N/A
4.6	Standing step ladders		
	The legs are connected with hinge joints and shall be secured from sliding apart.		P
	During the use of ladder, the steps shall be in horizontal position.		P
	The projection of the handrail onto the platform shall not go beyond the latter.	Considering the interior of the handrail.	P
	The radius of the horizontal edges of a platform shall be max 15 mm in order to avoid slipping at the edges of the platform.		P
	Functional sizes	(see appended table)	P
4.7	Standing rung and step ladders		
	The rung section shall be designed in accordance with 4.3 and the step section in accordance with 4.6.		N/A

EN 131-2			
4	REQUIREMENTS		
4.1	General		
	The requirements are based upon a maximum total load of 1 471 N (150 kg).		P
4.2	Materials		
4.2.1	Aluminium — alloy		
	All load bearing parts made of aluminium alloy shall have an elongation A5 at rupture measured according to EN ISO 6892-1 of minimum 5 %.	8% according to manufacturer declaration of conformity – EXTRUSAL.	P

EN 131-1 + EN 131-2 + EN 131-3			
Clause	Requirement + Test	Result - Remark	Verdict
	I load bearing parts made of aluminium alloy shall have a thickness of at least 1,2 mm.	Min measured: 1,26 mm on support profile. (A14/001)	P
4.2.2	Steel		
	If cold rolled steel or a special alloy-steel is used the ratio between 0,2 % yield-stress and ultimate strength (R_p 0,2/R _m) shall be lower than 0,92.	According to manufacturer certificate.	P
	All load bearing parts made of steel shall have a thickness of at least 1,0 mm.	Min measured: 1,2 mm on platform with coating removed. (A14/001)	N/A
4.2.3	Plastics		
	Glass-fibre reinforced plastics shall be:		
	- Protected against penetration of water and dirt;	No glass-fibre used on the step ladder construction.	N/A
	- The surface shall be smooth;		N/A
	- The fibres shall be embedded;		N/A
	- The Barcol hardness according to EN 59 shall be at least 35;		N/A
	- The minimum thickness for load-bearing elements made of thermoset plastics and composite material is 2 mm.		N/A
	Thermoplastic materials without reinforcements shall not be used for load bearing-elements.		P
	When using plastics materials, ageing and temperature resistance shall be taken into account.	According to manufacturer certificate.	P
4.2.4	Timber		
	Timber to be used shall have a bulk density greater than or equal to 450 kg/m ³ for softwoods and 690 kg/m ³ for hardwoods.	_____ kg/m ³	N/A
	The bulk density shall be measured with a moisture content of 15 %.		N/A
	General requirements.		N/A
	Traversing splay knots ¹⁾ are not permitted on any section of stiles or supporting elements.		N/A
	Pin knots with a diameter of less than or equal to 5 mm are permitted.		N/A
	In the upper and lower third of the stile or supporting element, one sound, intergrown knot ¹⁾ , of diameter d , less than or equal to $0,2 \times b$ (the width of the stile) is permitted per metre.		N/A
	For ladders made of laminated wood the above mentioned number, size and position of knots are allowed over the total length of the ladder.		N/A
	Intergrown pin knots up to a maximum diameter of 3 mm are admissible.		N/A
	The moisture content of the wood is to be chosen according to the equilibrium moisture content resulting from open air drying, normally in Europe 12 % to 20 %.		N/A

EN 131-1 + EN 131-2 + EN 131-3			
Clause	Requirement + Test	Result - Remark	Verdict
	Finger jointed wood shall be in accordance with EN 385. The result of the bending test of the finger jointing shall be in accordance with EN 385 and EN 408. The result of this test shall be in minimum 35 N/mm.		N/A
	The use of laminated wood is accepted if the wood used conforms with the requirements of 4.2.4.1 to 4.2.4.4 inclusive.		N/A
	The test of adhesive lines integrity and strength in laminated wood shall be in accordance with EN 391:2001, method A or B and EN 392. The result of this test shall be in accordance of the requirements on EN 386:2001, Table 1 and Table 2.		N/A
	Adhesives for connection stile — rung shall conform with EN 204, class D3.		N/A
	Adhesives for laminated wood shall conform with EN 301, type 1 or EN 204, D4.		N/A
4.3	Design		
	The design shall seek to minimize the existence of shearing and squeeze points and where they do exist to minimize the shearing and squeezing effects as far as practicable.		P
	All connections should be durable and have a strength corresponding to the strain.		P
	The connections should be designed in a manner that arising notch tensions remain low.		P
	Screws and nuts shall be secured against loosening, e.g. by means of self locking or mechanically locked safety devices.		N/A
	Nails are allowed only if their function is related to the production process, e.g. fixation during the drying of glues.		N/A
	Welding of joints is permitted if welding procedures and welding personnel are suitable. EN ISO 14731 and EN ISO 3834-1 to EN ISO 3834-4 have to be observed.		N/A
4.4	Surface finish		
	In order to avoid injuries, accessible edges, corners, and protruding parts shall be free of burrs, for example chamfered or rounded.		P
	Metal parts susceptible to corrosion shall be protected by means of a paint coating or other coating. Under normal conditions aluminium alloys are not susceptible to corrosion.	Platform with paint coating.	P
	Wooden parts shall be smoothed and coated on all sides. The coating shall be transparent and permeable to water vapour.	None wooden parts on the step ladder.	N/A
4.5	Hinges (turning points)		
	Hinges shall connect the legs of the standing rung ladders and the standing step ladders durably.		P
	Hinges shall be designed in such a manner that no abutment of the ladder parts over the hinges is formed during use of the ladder.		P
	The hinge pin shall be secured against unintentional loosening.		P
	Pins shall have at least the same strength as M 6 (5,3 mm) pins of steel 8.8.	Pin = 5,93 mm (I01/23)	P
	If the pin has several shearing points (piano hinge) there is no restriction as to the hinge pin diameter.		N/A

EN 131-1 + EN 131-2 + EN 131-3			
Clause	Requirement + Test	Result - Remark	Verdict
	The hinges shall satisfy the tests according to 5.8.		P
4.6	Opening restraints		
	The legs of the standing ladders shall be prevented from opening beyond the normal use configuration by means of opening restraints.	Anti-opening straps.	P
	If chains are used, all chain links with the exception of the first and the last one shall be free to move.		N/A
	The opening restraints shall satisfy the tests according to 5.8.		P
4.7	Rungs/steps/platforms		
	Rungs, steps and platforms made of metal or plastics shall have a textured surface on the working face to reduce slipping.	Rungs with textured surface.	P
	The contact surface of the coverings shall adhere firmly to the rungs or steps.		N/A
	Rungs and steps shall be firmly and durably connected to the stiles.	Steps are riveted on stiles.	P
	Wooden rungs shall be tenoned and mortised into the stiles and glued and wedged in the case of through tenon construction.		N/A
	The minimum dimensions of wooden rungs are 37 mm for stile and 21 mm for rung.		N/A
	Round rungs shall have a diameter greater than or equal to 25 mm.		N/A
	The top surface of flat standing surfaces shall have an angle less than or equal to 25° to the horizontal.		N/A
	For leaning ladders, the angle related to the stile shall be 65° to 90° for rungs and 60° to 70° for steps.		N/A
	Rungs/steps/platforms shall satisfy the tests according to 5.6 and 5.7.		P
4.8	Platform		
	If the topmost walking surface of a standing ladder is designed as a foldable platform, the latter shall be lifted up by a device when the ladder is folded.		P
	The platform shall satisfy the kick-up test according to 5.10.		P
4.9	Ladder feet and anti-skid devices		
	Bottom ends of the ladder shall be slip resistant.		P
4.10	Extending and sectional ladders		
4.10.1	Rung/step hooks/locking devices		
	The ladder parts of push-up extension ladders shall be secured from unintentional closing and separation in the position of use.		N/A
	All sectional and extending ladders shall be fitted with a locking device to keep the ladders hooks engaged on the rung during use. The locking device shall be capable of supporting the weight of the lower parts of the ladder.		N/A
	Locking devices on rope-operated extending ladders shall reliably ensure a safe catch.		N/A
	The rung/step hooks of rope-operated extension ladders shall be designed in such a way that the upper ladder parts cannot fall down by more than one rung per ladder part if the rope loosens or breaks. This safety requirement shall apply both when the ladder is vertical and in the position of use.		N/A
	During use of the ladder the rungs overlapping one another shall be in the same plane perpendicular to the stiles or in one horizontal plane or in any other plane between these.		N/A
4.10.2	Ropes		

EN 131-1 + EN 131-2 + EN 131-3			
Clause	Requirement + Test	Result - Remark	Verdict
	Ropes for extending ladders shall have a minimum strength of 4 000 N.		N/A
	Hand operated ropes shall have a minimum diameter of 8 mm.		N/A
	Synthetic ropes shall be stabilized against ultra violet light.		N/A
5	TESTING		
5.1	General		
	For all tests, unless otherwise stated in the particular test, the following tolerances apply:		
	- ± 1 mm for longitudinal measurements;		P
	- ± 5 mm for the measurement of the distance between the supports and the overhanging length;		P
	- $\pm 1^\circ$ for the measurement of angles;		P
	- ± 1 % for static forces and torque.		P
5.2	Strength test for all ladders		
	The test shall be carried out on the complete ladder.		N/A
	In the case of an extending ladder, the test shall be carried out with the ladder fully extended.		N/A
	In the case of a combination ladder, the test shall be carried out with the ladder fully extended in all of its usable configurations.		N/A
	In the case of standing ladders, the test shall be carried out with the ladder fully extended in the position of use.		P
	In the case of sectional ladders, the test shall be carried out with the ladder at full length with all permitted pieces.		N/A
	Where the ascendable side of the ladder cannot be determined by the construction of the product:		
	- It shall be tested twice;		N/A
	- For the test on the second side a new ladder shall be used;		N/A
	- Prior to carrying out the test on the second side of the new ladder, it shall be subjected to all of the preceding tests in the test sequence given in Table A.1.		N/A
	Ladders with separately extending stiles shall be tested with their stiles in the least favourable position.		N/A
	Lateral or pole type stabilizers shall not be deployed in this test if the design permits the ladder to be used with the lateral or pole type stabilizers removed or temporarily adjusted as permitted by EN 131-1:2015, 4.2.1, General.		N/A
	Erect the ladder in its position of use at the maximum extension, at $(65 \pm 0,5)^\circ$.		N/A
	The top shall rest against a smooth vertical surface and with the base of the ladder shall be restrain where it makes contact with the ground to prevent it slipping.		N/A
	The test load F shall be applied to the rung or tread nearest the centre of the ladder and at a point 50 mm from the inside of one stile and distributed over a 100 mm of the length of the rung or tread for a period of 1 min.	(A02/002; A11/004)	P
	Apply a test load of 2250 N for non-professional ladders.	F = 2250 N	P
	Apply a test load of 2700 N for professional ladders.		N/A

EN 131-1 + EN 131-2 + EN 131-3			
Clause	Requirement + Test	Result - Remark	Verdict
	Where the test ladder includes a base stabilizer bar then clearance under both stiles of the ladder of a minimum 10 mm shall exist throughout the test		N/A
	The ladder shall remain functional with no fracture or visible cracks.		P
	The ladder shall sustain the load without ultimate failure.		P
	Permanent deformation shall be allowed.	At the end of test, there's no visible deformations	N/A
5.3	Bending test of the stiles		
	The test shall be carried out on the complete ladder.		P
	In the case of extending ladders and combination ladders the test shall be carried out on the complete extended ladder.		N/A
	Sectional ladders shall be tested at full length with all permitted pieces.		N/A
	The test shall be carried out without supporting legs if not permanently fixed to the ladder.	Supporting legs permanently fixed to the ladder.	N/A
	Where the ascendable side cannot be determined by the construction of the product, the ladder shall be tested twice. For the second test the ladder shall be rotated 180° about the longitudinal axis.		N/A
	Where it is a multiple part combination ladder, the ladder shall be tested twice. For the second test the ladder shall be rotated 180° about the longitudinal axis.		N/A
	The test load shall be slowly applied in the middle of the ladder equally to both stiles over a width of 100 mm.	L = 1595 mm (A15/002)	P
	A pre-load of 100 N shall be applied for the duration of one min.	(A02/002; A11/004)	P
	The position of the ladder after removal of the pre-load is the origin for the measurement.		P
	A test load F of 750 N shall be applied vertically on the centre of the ladder for a duration of at least 1 min.	(A02/002; A11/004)	P
	Deflection measured (f)	$f_{mes} = 7,21$ mm	P
	Maximum permissible deflection (f_{max}):		
	- Length ≤ 5 m, $f_{max} = 5 \times L^2 \times 10^{-6}$ (mm)	$f_{max} = 12,72$ mm	P
	- Length > 5 m e ≤ 12 m, $f_{max} = 0,043 \times L - 90$ (mm)	$f_{max} = ___$ mm	N/A
	- Length > 12 m, $f_{max} = 0,06 \times L - 294$ (mm)	$f_{max} = ___$ mm	N/A
5.4	Lateral deflection test of the ladder		
	This test shall be conducted on all one-piece ladders as well as on each ascendable part of multiplepiece ladders.		N/A
	The test shall be conducted also on t the supporting-legs of standing rung- or step-ladders.		P
	The ladder shall be placed in the lateral position.		P
	A pre-load of 100 N shall be applied for the duration of one min to the lower stile equidistant from the supports.	$L_{Support} = 1500$ mm $L_{Access} = 1595$ mm (A15/002; A02/002; A11/004)	P
	The position of the ladder after removal of the pre-load is the origin for the measurement.		P
	A load F of 250 N shall be applied to the lower stile equidistant from the supports.	(A02/002; A11/004)	P

EN 131-1 + EN 131-2 + EN 131-3			
Clause	Requirement + Test	Result - Remark	Verdict
	The deflection is measured equidistant from the supports 1 min after loading.	$f_{\text{meas support}} = 7,48 \text{ mm}$ $f_{\text{meas access}} = 7,43 \text{ mm}$ (I01/23)	P
	Thereby the maximum permissible deflection f_{max} as a function of the distance l between the supports shall be $f_{\text{max}} = 0,005 \times L$ (mm).	$f_{\text{max support}} = 7,50 \text{ mm}$ $f_{\text{max access}} = 7,98 \text{ mm}$	P
5.5	Bottom stile ends test		
	Place the ladder laterally, with the longitudinal axis of the ladder in the horizontal position.		P
	The lower stile is to be fixed to the support so that the stile ends overhang the supporting surface		P
	If the rungs/steps are bolted, riveted, or similarly fixed to the stile the edge of the support shall be in line with the bottom lower edge of the assembling hole.		N/A
	If the rungs/steps are fixed to the stile without the stile being penetrated the edge of the support shall be in line with the lower edge of the rung/step.		P
	If the ladder has a bar type stabilizer then this test is not carried out.		N/A
	A rigid load block 50 mm wide is placed with its end up to and parallel with the end of the stile.		P
	A vertical force F of 1 100 N is placed in the middle of the load block and is maintained for one min.	(A15/002; A02/002; A11/004)	P
	The permanent deflection after removal of the test load together with any damages are noted.	$f_{\text{mes 1}} = 0,88 \text{ mm}$	P
	The test is repeated on the lower stile without turning the ladder.	$f_{\text{mes 2}} = 0,11 \text{ mm}$	P
	The permanent deflection f in each test shall not exceed 2 mm.		P
	Neither fracture nor visible cracks are allowed.		P
	This test shall also be performed on supporting legs.	$f_{\text{mes 1}} = 1,09 \text{ mm}$ $f_{\text{mes 2}} = 1,45 \text{ mm}$	P
5.6	Vertical load on rungs, steps and platforms		
5.6.1	General		
	A pre-load F of 200 N shall be applied for the duration of one min.	(A02/002; A11/004)	P
	The position of the rung/step/platform after removal of the pre-load is the origin for measurement.		P
5.6.2	Rungs and steps		
	In the position of use of the ladder a test load F of 2 600 N shall be applied vertically on the mid-point of the weakest rung or step of any design evenly distributed over a width of 100 mm and a depth equal to the rung/step and for the duration of one min.	(A15/002; A02/002; A11/004)	P
	Inner width b_1 measured underneath the tested step.	$b_1 = 458,9 \text{ mm}$ (D04/002)	P

EN 131-1 + EN 131-2 + EN 131-3			
Clause	Requirement + Test	Result - Remark	Verdict
	Maximum permanent deformation after removal of the test-load shall be: $f_{max} \leq 0,5\% \times b_1$.	$f_{max} = 2,29 \text{ mm}$ $f_{meas} = 0,72 \text{ mm}$ (I01/23)	P
5.6.3	Platform		
	The platform shall be tested at two positions, in the centre and at a corner of the front edge.		P
	With the ladder positioned as in use, a test load F of 2 600 N, uniformly distributed over an area of 100 mm x 100 mm shall be applied for the duration of one min.	(A15/002; A02/002; A11/004)	P
	Inner width b_1 shall be measured from above the platform parallel to the rungs or steps at the point where the load has been applied.	$b_1 = 330,4 \text{ mm}$	P
	The maximum permanent deformation after removal of each test load shall be: $f_{max} \leq 0,5\% \times b_1$.	$f_{mes1} = 1,59 \text{ mm}$ $f_{mes2} = 1,51 \text{ mm}$ (I01/23)	P
	The requirement after the second test shall be that no permanent deformation greater than 0,5 % of b_1 is visible at the connection between platform and stile measured from the underside.	$f_{max} = 1,65 \text{ mm}$	P
5.7	Torsion test of rungs and steps		
	A torque M of 50 Nm shall be applied on the midpoint of the rung or step via a 100 mm wide clamping device. The torque shall be applied alternately 10 times in clockwise and 10 times in counter-clockwise direction for a period of 10 s each.		P
	During testing there shall be no relative movement in the connection between stile and rung/step.		P
	After the test a permanent deformation shall be 1° at maximum with a tolerance of $\pm 0,2^\circ$.	$\alpha = 0^\circ$ (A11/003)	P
5.8	Test of opening restraints and hinges of standing ladders		
5.8.1	General		
	Each leg of the ladder in the working position is placed on a platform provided with multidirectional rollers.		P
	The effects of friction, from both the rollers and floor surface, shall be negligible. The test is to be conducted on a clean, smooth finish concrete floor.		P
	After removal of the test loads of the tests according to 5.8.2 to 5.8.4 no visible permanent deformation shall occur on the hinge joints, opening restraint devices and their attachments.		P
	The ladder shall not show any visible damages such as cracks, indentations, etc.		P
	Permanent deformation is acceptable only if it does not impair the fitness for use of the ladder.	There're no visible deformations.	N/A
5.8.2	Bilaterally ascendable ladder		
	The test load F of 2 600 N is divided into two loads of 1300 N, distributed over two plates each 100 mm long with a width at least equal to the surface of the rung or step to be applied to the uppermost rung or step as close as possible to the stiles for a duration of 1 min.		N/A

EN 131-1 + EN 131-2 + EN 131-3			
Clause	Requirement + Test	Result - Remark	Verdict
	This test is then repeated on the other leg.		N/A
5.8.3	Standing ladder with platform		
	The test load F of 2 600 N is divided into two loads of 1 300 N, distributed over two plates that are each 100 mm x 100 mm to be applied to front edge of the platform as close as possible to the stiles for a duration of 1 min.	Test performed on 8 steps model, with anti-opening straps, and on 4 steps variant with no anti-opening straps. (A15/002; A02/002; A11/004)	P
	This test is then repeated on the rear edge of the platform.		P
5.8.4	Unilaterally ascendable ladder		
	The test load F of 2 600 N is divided into two loads of 1 300 N, distributed over two plates each 100 mm long with a width at least equal to the surface of the rung or step to be applied to the uppermost rung or step of the ascending leg as close as possible to the stiles for a duration of 1 min.		N/A
5.9	Test for ladder rung/step hooks of extending ladders and combination ladders		
	The ladder is extended by at least one rung/step distance and placed in a vertical position.		N/A
	A uniformly distributed test load F of 3500 N shall be applied vertically to the upper part of the ladder for a period of 1 min.		N/A
	After removal of the test load, there shall be no permanent deformation which impairs the fitness for use of the ladder.		N/A
5.10	Kick-up test of the platform of standing ladders		
	Place the standing ladder in the working position on a level surface and apply a force F of 100 N over a 100 mm width to the pivoted edge of the platform at an angle of 90° to the horizontal towards the vertical centre line of the steps.	(A15/002; A02/002; A11/004)	P
	The platform shall not lift from its stop by more than 6°.	$\alpha = 0,6^\circ$ (A11/003)	P
5.11	Feet pull test		
5.11.1	For ladder feet made of one part		
	Fix the ladder. Attach a fixing to the centre of a ladder foot. The force is to be applied in a direction most likely to separate the foot from the stile.		P
	A load of 150 N shall be applied for 1 min.	(A14/002; A11/004)	P
	After the test, the foot shall remain functional and show a separation from the stile of less than or equal to 4 mm.	Access foot: < 1 mm Support foot: < 2,5 mm (I01/23)	P
5.11.2	For feet made of one part on stabilizer bars supplied by the ladder manufacturer		
	Prevent the ladder from moving by placing stops around one pair of feet.		N/A
	Apply the force to a free foot in the position and direction most likely to separate the foot from the stabilizer bar.		N/A
	A load of 150 N shall be applied for 1 min.		N/A
	After the test, the foot shall remain functional and show a movement from its original position of less than or equal to 4 mm.		N/A
5.11.3	For ladder feet and feet of stabilizer bars made of more than one part		

EN 131-1 + EN 131-2 + EN 131-3			
Clause	Requirement + Test	Result - Remark	Verdict
	The relevant test in 5.11.1 or 5.11.2 shall be performed.		N/A
	Additionally, the section of the foot that generates resistance to movement relative to the ground shall have a load of 150 N applied for 1 min in a location and direction that is likely to be the most critical, as determined by the tester.		N/A
	After the test, there shall be no indication of separation between the different parts of the foot.		N/A
	If the sections of the ladder foot that provide the friction between the ladder and the ground are loosened or lost, this shall be clearly visible when the ladder is in the position of use.		N/A
	The sections of the ladder foot that are designed to provide the friction between the ladder and the ground shall be the only part of the foot in contact with the ground under user or test load with in the position of use.		N/A
	This part of the ladder foot, even when worn, shall not be capable of being pushed inside the upper part of the foot when the ladder is in the position of use.		N/A
5.12	Test on hand-/kneerails		
5.12.1	Standing ladder top hand-/kneerails		
	The standing ladder shall be fixed horizontally.		P
	A vertical load of 300 N is applied to the top centre of the hand-/kneerail.	(A15/002; A02/002)	P
	The load shall be applied for 1 min over a length of 100 mm and a width at least equal to the hand-/kneerail material.	(A11/004)	P
	After the test, the hand-/kneerail shall not show any visible permanent deformation, which does impair the fitness for use of the ladder.		P
5.12.2	Side handrail		
	Set up the ladder in its position of use and at its fully extended length in accordance with the manufacturer's instructions		N/A
	Place a stop to prevent movement of the foot of the stile to which the handrail being tested is attached. Apply a static load F of 400 N over a 100 mm pad to the centre of the rung or tread nearest the centre of the extended ladder.		N/A
	Maintain this load in position for the duration of the tests. Apply each test force according to Table 3 sufficiently slowly to eliminate any dynamic effects.		N/A
	Apply each force 10 times and maintain it for 5 s each time.		N/A
	Apply outward forces A, B and C in two directions (perpendicular and parallel to the plane of the ladder) and downward force D parallel to the plane of the ladder.		N/A
	Apply the forces given in Table 3 at the positions shown in Figure 25 and apply the outward forces A, B and C also at any other point on the handrail which due to its design is likely to cause failure.		N/A
	Apply each force separately.		N/A
	Upon completion of the tests there shall be no failure of handrail fixings		N/A
	A The permanent deformation at the points of application of load shall not exceed 15 mm.	d = ___ mm	N/A

EN 131-1 + EN 131-2 + EN 131-3			
Clause	Requirement + Test	Result - Remark	Verdict
	The distance between the stile and the handrail during the test shall not be less than 15 mm.	d = ___ mm	N/A
5.13	Maximum extension of ladder		
	Extend the ladder to the maximum possible length. The lower stile ends of the upper sections are not permitted to pass the second rung from top of the section underneath		N/A
5.14	3-part combination ladder in A-position test		
	For a three-part combination ladder in the "A" position with the top section fully extended in the working position.		N/A
	The free movement of the top section shall be less than or equal to 5°.	$\alpha = \text{___}^\circ$	N/A
5.15	Torsion test for standing ladders		
	The test shall be carried out on all standing ladders and all combination ladders in standing ladder mode		P
	The test shall be carried out with the standing ladder in the position of use on a flat, smooth and level floor.		P
	One stile of the front section shall be secured to locate the ladder.		P
	Mark the floor adjacent to the other stile to form a datum for measurement.		P
	A rigid steel load bar is secured to the front face of the ladder at the level of the topmost rung or step or in the case of a platform ladder, at the level of the platform.		P
	The load bar shall project sideways 0,5 m horizontally from the centre line of ladder and on the opposite side of the ladder to the clamp.	(A15/002)	P
	A vertical load F_1 of 736 N uniformly distributed, is applied to topmost rung or step or the platform of the ladder.	(A02/002)	P
	A horizontal load F_2 of 137 N shall be applied to the end of the load bar towards the rear of the ladder perpendicular to the bar and parallel to the ground.	(D04/001)	P
	The front stile of the ladders that is not clamped to the floor shall not move more than 25 mm from its datum position whilst the horizontal load is applied.	d = 5 mm	P
5.16	Test methods for plastic ladders		
5.16.1	Thermoset plastics and composite materials		N/A
5.16.2	Reinforced thermoplastics		N/A
5.16.3	Dielectric test		
5.16.3.1	General		
	The dielectric test applies for the suitability of ladders for a use where the voltage is less than 1 000 V a.c and 1 500 V d.c.		N/A
	The tests shall be mandatory for all ladders declared as insulated.		N/A
	When ladders are used where the electrical voltage is greater than 1 000 V, then the ladders shall comply with EN 61478.		N/A
5.16.3.2	Preparation of the test piece		
	The test piece is taken from the ladder and shall include at least two adjacent rungs.		N/A

EN 131-1 + EN 131-2 + EN 131-3			
Clause	Requirement + Test	Result - Remark	Verdict
	In the case of spliced ladder, the test piece shall include the part with the connecting device (most sensitive part of the ladder).		N/A
	The dielectric test is carried out on the insulation material sections, which have undergone a mechanical ageing test as described in 5.16.1.3.		N/A
5.16.3.3	Procedure		
	The section is immersed for 24 h in water with a resistivity of $(100 \pm 15) \Omega \times m$.		N/A
	The ladder is then removed from the water bath and hung upright for 4 h. Prior to applying the test voltage the ladder is wiped carefully.		N/A
	Suitable electrodes, at least 50 mm in width, are attached to two successive rungs. These are positioned so as to ensure that the test voltage is applied to the stiles		N/A
	The voltage applied between adjacent electrodes is an alternative voltage with a frequency between 40 Hz and 62 Hz, increasing gradually from 0 to U_m , at the rate of 1 kV/s.		N/A
	The test voltage U_m is defined according to the spacing d between the 2 rungs by the equation: $U_m = 1\,000 \times d/300$		N/A
	Voltage is provided by a transformer with a short-circuit current that is not less than 0,5 A at U_m .		N/A
	The U_m voltage is applied for 1 min.		N/A
	The test is carried out on the adjacent rungs and in contact with the stiles (rails).		N/A
	The test is considered as passed if no flashover, no puncture and no temperature rise ($\Delta 5 \text{ }^\circ\text{C}$) occurs on the stiles.		N/A
5.17	Durability test for standing ladders		
5.17.1	General		
	This test is for standing ladders or any ladder that can be used as a standing ladder.		P
	The test has criteria of 10000 cycles for non-professional class and 50000 cycles for professional class and this test to be a conditioning test before the test of opening restraints and hinges of standing ladders.	Ladder tested for non-professional class.	P
5.17.2	Principle		
	The standing ladder is placed in position of use on the testing surface with the 4 standing ladder stiles constrained to a fixed part by elastic rope/tape to prevent excessive progressive movement of the standing ladder-		P
	Two equal loads P_1 and P_2 are applied to the standing ladder by testing apparatus following a well-defined load versus time law of cycles: one load is applied to the topmost rung/step/platform and the other one is applied to the rung/step in the middle of the ascending leg.		P
	The load application shall continue until the defined load value is no longer maintained by the thrust device or until to the collapse of standing ladder or until the defined number of cycles for each class has been achieved.		P
5.17.4	Test condition - Ambient condition		

EN 131-1 + EN 131-2 + EN 131-3			
Clause	Requirement + Test	Result - Remark	Verdict
	The ambient temperature shall be (20 ± 5) °C before testing and remain within this temperature range during the test.		P
5.17.5	Test requirements		
	The load shall be applied to achieve the pattern of loading as shown in Figure 34.		P
5.17.6	Test procedure		
a)	verify that no defects are present on the standing ladder;		P
b)	place the standing ladder in its position of use at its maximum extension with opening restraints engaged on the test surface with one of the rear feet positioned on the 20 mm thick flat raised element, in order to simulate an uneven surface (see Figure 30);		P
c)	determine the rung/step at the position located horizontally from the mid-point of <i>l</i> 2 on the ascending leg. If no rung/step is suitably positioned, then select the closest rung/step above this location;		P
d)	place one pad/cylinder (P2) on the rung/step determined in (c) so that its centreline is (70 ± 5) mm from the inside face of the stile corresponding to the side of the ladder where the rear foot is positioned on the 20 mm thick raised element (see Figures 32 and 33);		P
e)	adjust the pad/cylinder so that its vertical distance to the rung/step surface is (5 ± 2) mm (see Figures 32 and 33);		P
f)	place the second pad/cylinder (P1) on the top rung/step/platform so that its centreline is (70 ± 5) mm from the inside face of the opposite stile to P2 and adjust it so that the vertical distance from the pad/cylinder to the rung/step surface is (5 ± 2) mm (see Figures 32 and 33);		P
g)	constrain each of the 4 ladder stiles to a fixed element (e.g.by elastic ropes, tapes) to prevent excessive progressive movement of the ladder;		P
h)	verify that each pad/cylinder is separately capable of exerting the test load of $(1\ 500 \pm 50)$ N;	(A18/002; D04/001)	P
i)	start the test as per the test load sequence described in 5.17.5;		P
j)	the load application shall continue until: 1) the defined load value of (1500 ± 50) N is not maintained by the thrust device (ladder collapse), or 2) the rupture of the standing ladder, or 3) the number of cycles required by the class has been reached without collapse or rupture of the standing ladder; 4) the maximum number of cycles of the test step is registered.		P
5.18	Base slip test for leaning ladders		
5.18.1	Ladders to be tested		
	All leaning ladders or ladders that may be used as a leaning ladder shall be tested in accordance with Table 5.		N/A
	Where the ascendable side cannot be determined, the test shall be repeated.		N/A
	For the second test the ladder shall be rotated 180° about its longitudinal axis.		N/A

EN 131-1 + EN 131-2 + EN 131-3			
Clause	Requirement + Test	Result - Remark	Verdict
	Optionally, a second ladder may be used.		N/A
	Where ladders have stabilizing devices they should be deployed in this test the way the manufacturer designed.		N/A
	In the case of combination ladders that may be used as a leaning ladder, they shall be tested as a leaning ladder.		N/A
	The feet of the ladder shall be new.		N/A
	The surface supporting the base of the ladder shall be a sheet of float glass conforming to the requirements of EN 572-2. The glass shall be of a suitable thickness to support the weight of the ladder.		N/A
	The surface supporting the upper end of the ladder shall be firm and smooth stainless steel, smooth glass or smooth high pressure laminate.		N/A
5.18.3	Test procedure		
	The ladder shall be positioned at an angle of 75° or the maximum angle up to 75° permitted by the design.		N/A
	Its feet shall be on the float glass base and with the top of the ladder resting against the upper supporting surface.		N/A
	Confirm the angle of the ladder is correct by measuring it with an inclinometer accurate to within $\pm 0,5^\circ$ positioned on the stiles and adjacent to the base of the ladder.		N/A
	The base of the ladder shall be restrained to prevent outward movement.		N/A
	A datum shall be established at the base of the ladder as the origin of measurement for outward movement of the feet of the ladder.		N/A
	The air temperature shall be measured within 100 mm measured horizontally from the ladder feet and at a height no greater than 10 mm from the float glass surface supporting the base of the ladder. The surface temperature of the float glass supporting the base of the ladder, the ladder feet and the air temperature surrounding the feet shall be $(20 \pm 2)^\circ\text{C}$ before the testing and shall remain within this range during the testing.		N/A
	A vertical downwards test load of 1 471 N shall be applied to the midpoint of the fourth rung down from the top of the ladder		N/A
	The feet of the ladder shall be allowed to settle for a period of 2 min.		N/A
	The restraint preventing outward movement of the base of the ladder shall then be removed.		N/A
	After a period of 1 min the restraint preventing outward movement of the ladder shall be replaced.		N/A
	Measure any outward movement of the ladder feet relative to datum established for the origin of measurement.		N/A
	Repeat the test procedure 4 times.		N/A
5.18.4	Test requirement		
	The ladder feet shall not move outwards more than 40 mm with respect to the origin for measurement.		N/A
5.19	Strength test for lateral type stabilizers on leaning ladders which are in the plane of the ladder		
5.19.1	Test Procedure		

EN 131-1 + EN 131-2 + EN 131-3			
Clause	Requirement + Test	Result - Remark	Verdict
	Position the ladder against a supporting vertical surface at an angle α of $(75 \pm 0,5)^\circ$.		N/A
	The supporting surface at the base of the ladder shall be smooth and level.		N/A
	Fix or block the ladder at the bottom end of the stiles to prevent outward movement during the test.		N/A
	Apply a vertical test load F of 1 471 N, through a point on a loading device which is attached to the rung/tread, 100 mm outside of the stile of the ladder and level with the first rung of the ladder above the uppermost connection point between the ladder and the stabilizer for a duration of 1 min.		N/A
	Remove the test load.		N/A
5.19.2	Test requirement		
	After removal of the test load the ladder, stabilizers and their connections shall remain functional with no fracture or visible cracks.		N/A
5.20	Strength test for pole type stabilizers on leaning ladders which are not in the plane of the ladder		
5.20.1	Test procedure		
	Position the ladder in a tripod configuration on a smooth and level supporting surface at an angle α of $(75 \pm 0,5)^\circ$ with its upper end unsupported.		N/A
	Extending ladders shall be set in the closed position.		N/A
	Fix or block the ladder and the poles at the bottom end to prevent movement during the test.		N/A
	Apply a vertical downwards test load F of 1471 N to a rigid block 100 mm wide, positioned centrally on the first rung of the ladder below the uppermost connection point between the ladder and the stabilizer for a duration of 1 min.		N/A
	Remove the test load.		N/A
5.20.2	Test requirement		
	After removal of the test load the ladder, stabilizers and their connections shall remain functional with no fracture or visible cracks.		N/A
5.21	Torsion test for leaning ladders		
5.21.1	Test Procedure		
	The test shall be carried out on the complete ladder.		N/A
	In the case of extending ladders and combination ladders the test shall be carried out on the complete extended ladder.		N/A
	Sectional ladders shall be tested at full length with all permitted pieces.		N/A
	Where the ascendable side of the ladder cannot be determined by construction of the product it shall be tested twice.		N/A
	For the test on the second side a new ladder shall be used.		N/A
	Prior to carrying out the test on the second side of the new ladder, it shall be subjected to all of the preceding tests in the test sequence given in Table A.1		N/A

EN 131-1 + EN 131-2 + EN 131-3			
Clause	Requirement + Test	Result - Remark	Verdict
	The ladder shall be placed horizontally with the climbing face uppermost on supports situated 200 mm from each end of the ladder. The supports shall be cylindrical with diameters between 25 mm and 100 mm and one shall be free to rotate about its longitudinal axis and the other shall be fixed.		N/A
	Measure the clear span between the supports. This is regarded as the test span for the purpose of this test.		N/A
	Apply a preload of 491 N, vertically, at the middle of the ladder, distributed over 50 mm for a duration of 30 s, so that the stiles are loaded equally.		N/A
	Remove this load and establish a datum.		N/A
	Then apply a test load of 638 N, to the centre point of one stile distributed over 50 mm.		N/A
	After a period of not less than 30 s from the application of the full test load, by any convenient means, measure the vertical deflection at the centre of the effective span of both stiles from the established datum.		N/A
	Test Requirement		
	When tested in accordance with 5.21.1, the difference between the deflections of the two stiles shall meet the following equation: $f_1 - f_2 \leq 0,07b_U$		N/A
6	Marking and user instructions		
	Ladders should be marked with the relevant parts of EN 131 to which they fully comply and the year of revision(s).		P
	The marking shall be in accordance with EN 131-3.		P
	Marking shall be durable. The durability of the marking shall be checked by inspection and by rubbing the marking lightly, first for 15 s with a cloth soaked in water and then for 15 s with a cloth soaked in petroleum spirit.	(A11/004)	P
	There shall be no reduction in legibility at the conclusion of the test.		P
	Adhesive labels, where used, shall not have worked loose or become curled at the edges.		P
	User instructions in accordance with EN 131-3 shall be provided.		P
7	Certification		
	This standard may be a basis for a certification.		N/A
ANEXO B	A-deviations		
	A-deviation for Italy		N/A
	A-deviation for The Netherlands		N/A
	A-deviation for Sweden		N/A
EN 131-3			
4	PROVISION OF SAFETY MARKING AND USER INSTRUCTIONS		
	The producer shall be responsible for the content of the safety marking and user instructions and the provision of the instructions for each ladder.		P
	The safety marking and user instructions shall be in the language of the country where the ladder is originally placed on the market.	PT	P

EN 131-1 + EN 131-2 + EN 131-3																			
Clause	Requirement + Test	Result - Remark	Verdict																
	The user instruction shall indicate that it shall be read before using the ladder.		P																
	The distributor shall ensure that the safety marking and user instructions are provided for each ladder and that the user instructions are provided in the official languages of the country where the ladder is placed on the market.		P																
6	MARKING AND USER INSTRUCTION																		
6.1	General																		
	All marking detailed under Clause 6 shall be fixed permanently, according to EN 131-2, to the ladder surface.		P																
	The user instruction shall list the items to be inspected and checked - the minimum list of items is shown in Annex A.		P																
	The user instruction shall be supplied with the ladder and should be made available on the producer's website also.		P																
	The user instruction shall include identity and address of the producer and/or distributor including website address.		P																
	User instructions shall repeat all safety markings which are on the ladder.		P																
	The maximum number of safety signs should be reduced to a number that users are able to identify and comply with when using the ladder.		P																
6.2	Basic marking on the ladder																		
	Basic marking information may be given in the form of safety signs or text.																		
	The marking shall include:																		
a)	identity and address of the producer and/or distributor including website address for information about the ladder;		P																
b)	type of ladder and possible modes of use (description of the type, number and length of the parts, maximum length of ladder in use, maximum standing height measured in position of use according to the recommendation of the manufacturer);	<table border="1"> <thead> <tr> <th>No. Steps</th> <th>Height (mm)</th> </tr> </thead> <tbody> <tr> <td>8</td> <td>1770</td> </tr> <tr> <td>7</td> <td>1530</td> </tr> <tr> <td>6</td> <td>1290</td> </tr> <tr> <td>5</td> <td>1050</td> </tr> <tr> <td>4</td> <td>810</td> </tr> <tr> <td>3</td> <td>570</td> </tr> <tr> <td>2</td> <td>333</td> </tr> </tbody> </table>	No. Steps	Height (mm)	8	1770	7	1530	6	1290	5	1050	4	810	3	570	2	333	P
No. Steps	Height (mm)																		
8	1770																		
7	1530																		
6	1290																		
5	1050																		
4	810																		
3	570																		
2	333																		
c)	classification of use "professional" or "non-professional" as specified in EN 131-2;	Non-professional.	P																
d)	number of the general standard EN 131 or if a dedicated standard exists (e.g. a multi-hinge ladder according to EN 131-4) the number of this standard (e.g. EN 131-4).;		N/A																
e)	month and year of production and/or serial number (may also be stamped);	Year: 2020 Month: 03	P																

EN 131-1 + EN 131-2 + EN 131-3				
Clause	Requirement + Test	Result - Remark		Verdict
f)	weight of the ladder (in kg) and maximal total load (in kg);	No. Steps	Weight (kg)	P
		8	6,56	
		7	5,82	
		6	4,91	
		5	4,19	
		4	3,59	
		3	3,01	
g)	insulation, if any.			N/A
	Information a), b), c) and f) shall also appear on the packaging or be otherwise clearly visible to the consumer before the purchase.	The packaging wrap is transparent.		P
6.3	Safety marking and user instructions			
6.3.1	General			
	The basic safety marking shall be attached to all ladders and ladder parts which can be used separately as an easily viewed symbol.			P
	The marking to indicate the top most rung/step that shall be used for standing on, shall be placed:			
	- on the stile of the ladder adjacent to or on the last /allowed; or			N/A
	- on the first /not allowed rung/step; or			N/A
	- on the label for safety marking.			P
	The user instructions shall be written in the official languages of the country where the ladder is placed on the market in accordance with EN 82079-1.			P
6.3.3	Basic safety marking and user instructions for all ladders			
	Item/Text	Safety marking	User instruction	
1	Warning, fall from the ladder. This warning sign shall appear on each marking on the ladder at the first place.	<input checked="" type="checkbox"/>	<input checked="" type="checkbox"/>	P
2	Refer to instruction manual/booklet	<input checked="" type="checkbox"/>	<input checked="" type="checkbox"/>	P
3	Inspect the ladder after delivery. Before every use visually check the ladder is not damaged and is safe to use. Do not use a damaged ladder.	<input checked="" type="checkbox"/>	<input checked="" type="checkbox"/>	P
4	Maximum total load	<input checked="" type="checkbox"/>	<input checked="" type="checkbox"/>	P
5	Do not use the ladder on a unlevel or unfirm base.	<input checked="" type="checkbox"/>	<input checked="" type="checkbox"/>	P
6	Do not overreach.	<input checked="" type="checkbox"/>	<input checked="" type="checkbox"/>	P
7	Do not erect ladder on contaminated ground.	<input type="checkbox"/>	<input checked="" type="checkbox"/>	P
8	Maximum number of users	<input checked="" type="checkbox"/>	<input checked="" type="checkbox"/>	P
9	Do not ascend or descend unless you are facing the ladder.	<input type="checkbox"/>	<input checked="" type="checkbox"/>	P
10	Keep a secure grip on the ladder when ascending and descending. Maintain a handhold whilst working from a ladder or take additional safety precautions if you cannot.	<input type="checkbox"/>	<input checked="" type="checkbox"/>	P
11	Avoid work that imposes a sideways load on ladders, such as side-on drilling through solid materials.	<input type="checkbox"/>	<input checked="" type="checkbox"/>	P
12	Do not carry equipment which is heavy or difficult to handle while using a ladder.	<input type="checkbox"/>	<input checked="" type="checkbox"/>	P
13	Do not wear unsuitable footwear when climbing a ladder.	<input type="checkbox"/>	<input checked="" type="checkbox"/>	P

EN 131-1 + EN 131-2 + EN 131-3				
Clause	Requirement + Test	Result - Remark		Verdict
14	Do not use the ladder if you are not fit enough. Certain medical conditions or medication, alcohol or drug abuse could make ladder use unsafe.	<input type="checkbox"/>	<input checked="" type="checkbox"/>	P
15	Do not spend long periods on a ladder without regular breaks (tiredness is a risk).	<input type="checkbox"/>	<input checked="" type="checkbox"/>	P
16	Prevent damage of the ladder when transporting e.g. by fastening and, ensure they are suitably placed to prevent damage.	<input type="checkbox"/>	<input checked="" type="checkbox"/>	P
17	Ensure the ladder is suitable for the task.	<input type="checkbox"/>	<input checked="" type="checkbox"/>	P
18	Do not use the ladder if contaminated, e.g. with wet paint, mud, oil or snow.	<input type="checkbox"/>	<input checked="" type="checkbox"/>	P
19	Do not use the ladder outside in adverse weather conditions, such as strong wind.	<input type="checkbox"/>	<input checked="" type="checkbox"/>	P
20	For professional use a risk assessment shall be carried out respecting the legislation in the country of use.	<input type="checkbox"/>	<input type="checkbox"/>	N/A
21	When positioning the ladder take into account risk of collision with the ladder e.g. from pedestrians, vehicles or doors. Secure doors (not fire exits) and windows where possible in the work area.	<input type="checkbox"/>	<input checked="" type="checkbox"/>	P
22	Warning, electricity hazard. Identify any electrical risks in the work area, such as overhead lines or other exposed electrical equipment and do not use the ladder where electrical risks occur.	<input type="checkbox"/>	<input checked="" type="checkbox"/>	P
23	Use non-conductive ladders for unavoidable live electrical work.	<input type="checkbox"/>	<input checked="" type="checkbox"/>	P
24	Do not use the ladder as a bridge.	<input type="checkbox"/>	<input checked="" type="checkbox"/>	P
25	Do not modify the ladder design.	<input type="checkbox"/>	<input checked="" type="checkbox"/>	P
26	Do not move a ladder while standing on it.	<input type="checkbox"/>	<input checked="" type="checkbox"/>	P
27	For outdoor use caution to the wind.	<input type="checkbox"/>	<input checked="" type="checkbox"/>	P
28	If a ladder is delivered with stabilizer bars and these bars should be fixed by the user before the first use this shall be described on the ladder and in the user instruction.	<input checked="" type="checkbox"/>	<input checked="" type="checkbox"/>	N/A
29	Ladder for domestic use.	<input checked="" type="checkbox"/>	<input checked="" type="checkbox"/>	P
30	Ladder for professional use.	<input type="checkbox"/>	<input type="checkbox"/>	N/A
6.3.4	Leaning ladders – Additional requirements			
	Item/Text	Safety marking	User instruction	
1	Leaning ladders with rungs shall be used at the correct angle.	<input checked="" type="checkbox"/>	<input checked="" type="checkbox"/>	N/A
2	Leaning ladders with steps shall be used that the steps are in a horizontal position.	<input checked="" type="checkbox"/>	<input checked="" type="checkbox"/>	N/A
3	Ladders used for access to a higher level shall be extended at least 1 m above the landing point and secured, if necessary.	<input checked="" type="checkbox"/>	<input checked="" type="checkbox"/>	N/A
4	Only use the ladder in the direction as indicated, only if necessary due to design of ladder.	<input checked="" type="checkbox"/>	<input checked="" type="checkbox"/>	N/A
5	Do not lean the ladder against unsuitable surfaces.	<input checked="" type="checkbox"/>	<input checked="" type="checkbox"/>	N/A
6	Ladder shall never be moved from the top.	<input type="checkbox"/>	<input checked="" type="checkbox"/>	N/A
7	Do not stand on the top three steps/rungs of a leaning ladder. For telescopic ladders the last metre shall not be used (see 6.3.9).	<input checked="" type="checkbox"/>	<input checked="" type="checkbox"/>	N/A
6.3.5	Standing ladders – Additional requirements			
	Item/Text	Safety marking	User instruction	
1	Do not step off the side of standing ladder onto another surface.	<input checked="" type="checkbox"/>	<input checked="" type="checkbox"/>	P
2	Open the ladder fully before use.	<input checked="" type="checkbox"/>	<input checked="" type="checkbox"/>	P
3	Use the ladder with restraint devices engaged only.	<input type="checkbox"/>	<input checked="" type="checkbox"/>	P

EN 131-1 + EN 131-2 + EN 131-3				
Clause	Requirement + Test	Result - Remark		Verdict
4	Standing ladders shall not be used as a leaning ladder unless it is designed to do so.	<input type="checkbox"/>	<input checked="" type="checkbox"/>	P
5	Do not stand on the top two steps/rungs of a standing ladder without a platform and a hand/knee rail.	<input checked="" type="checkbox"/>	<input checked="" type="checkbox"/>	N/A
6	Any horizontal surface which looks like a platform on a standing ladder that is not designed for standing on (e.g. a plastic work tray) shall be clearly indicated on that surface, (only if necessary due to design of ladder).	<input checked="" type="checkbox"/>	<input checked="" type="checkbox"/>	N/A
6.3.6	Combination ladders – Additional requirements			
	Item/Text	Safety marking	User instruction	
1	Do not climb above the rung or tread recommended by the producer, of a combination ladder used in the standing ladder position, with extending ladder at the top (see Figure 3) or in the stairway position – to be indicated on the rung.	<input checked="" type="checkbox"/>	<input checked="" type="checkbox"/>	N/A
	Alternatively, the rungs or treads not to be used may be indicated on the ladder – to be indicated on the ladder.	<input checked="" type="checkbox"/>	<input checked="" type="checkbox"/>	N/A
2	Locking devices shall be checked and be fully secured before use if not operated automatically.	<input checked="" type="checkbox"/>	<input checked="" type="checkbox"/>	N/A
	The minimum requirement shall always be: Do not climb above the top four steps/rungs.			N/A
	When the safety marking is indicated on the rung, the minimum height of these symbols shall be 15 mm and the minimum width shall be 30 mm.			N/A
6.3.7	Extending ladders – Additional requirements			
	Item/Text	Safety marking	User instruction	
1	Locking devices shall be checked and be fully secured before use if not operated automatically.	<input checked="" type="checkbox"/>	<input checked="" type="checkbox"/>	N/A
2	The loose end of the rope shall be tied to the ladder (only if necessary due to design of ladder).	<input type="checkbox"/>	<input checked="" type="checkbox"/>	N/A
6.3.8	Single or multi-hinge joint ladders – Additional requirements			
	Item/Text	Safety marking	User instruction	
1	Single or multiple joint ladders should be unfolded/folded when lying on the ground and not in its use position.	<input type="checkbox"/>	<input checked="" type="checkbox"/>	N/A
2	If the ladder is used as a platform, only deckings recommended by the ladder producer shall be used. The decking shall be secured before use (only if necessary due to design of ladder).	<input checked="" type="checkbox"/>	<input checked="" type="checkbox"/>	N/A
3	Prohibited positions (see EN 131–4:2007, Clause 7): M-position, upside-down position (only if necessary due to design of ladder).	<input type="checkbox"/>	<input checked="" type="checkbox"/>	N/A
4	Max. load of platform in scaffold position (see EN 131–4:2007, Clause 7) declared by the manufacturer (120 kg to 150 kg) (only if necessary due to design of ladder).	<input checked="" type="checkbox"/>	<input checked="" type="checkbox"/>	N/A
5	Ensure that the hinges are locked.	<input checked="" type="checkbox"/>	<input checked="" type="checkbox"/>	N/A
	Where a single or multi-hinge joint ladder is designed to be used as a leaning ladder, the safety marking and user instructions shall comply with the requirements of 6.3.4.			N/A
	Where a single or multi-hinge joint ladder is designed to be used as a standing ladder, the safety marking and user instructions shall comply with 6.3.5.			N/A
6.3.9	Telescopic ladders – Additional requirements			N/A
	Item/Text	Safety marking	User instruction	
1	All locking mechanisms for all extended rungs/steps shall be checked and be locked before use.	<input checked="" type="checkbox"/>	<input checked="" type="checkbox"/>	N/A
2	Instruction for handling of locking mechanisms including indication of locked or unlocked position.	<input type="checkbox"/>	<input checked="" type="checkbox"/>	N/A

EN 131-1 + EN 131-2 + EN 131-3				
Clause	Requirement + Test	Result - Remark		Verdict
3	Do not bring your hands / fingers in rung area (area of shearing) when bringing the ladder in to its possible positions of use.	<input checked="" type="checkbox"/>	<input checked="" type="checkbox"/>	N/A
4	Do not stand on the last metre of a telescopic ladder.	<input checked="" type="checkbox"/>	<input checked="" type="checkbox"/>	N/A
	Where a single or multi-hinge joint ladder is designed to be used as a leaning ladder, the safety marking and user instructions shall comply with the requirements of 6.3.4.			N/A
	Where a single or multi-hinge joint ladder is designed to be used as a standing ladder, the safety marking and user instructions shall comply with 6.3.5.			N/A
6.3.10	Mobile ladders with platform – Additional requirements			
	Item/Text	Safety marking	User instruction	
1	Do not step off the side of the mobile platform ladder onto another surface.	<input type="checkbox"/>	<input checked="" type="checkbox"/>	N/A
2	Fully open before use (foldable mobile platform ladders).	<input checked="" type="checkbox"/>	<input checked="" type="checkbox"/>	N/A
3	Use the ladder with restraint devices engaged only (only if necessary due to design of ladder).	<input type="checkbox"/>	<input checked="" type="checkbox"/>	N/A
4	Any horizontal surface which looks like a platform on a mobile platform ladder that is not designed for standing on (e.g. a plastic work tray) shall be clearly indicated on that surface, (only if necessary due to design of ladder).	<input checked="" type="checkbox"/>	<input checked="" type="checkbox"/>	N/A
5	Use only with stabilizer (if part of the ladder).	<input checked="" type="checkbox"/>	<input checked="" type="checkbox"/>	N/A
6	Use only with ballast (if part of the ladder).	<input checked="" type="checkbox"/>	<input checked="" type="checkbox"/>	N/A
7	Use only with activated brakes (if part of the ladder).	<input checked="" type="checkbox"/>	<input checked="" type="checkbox"/>	N/A
8	Do not use ladders outdoors which are not intended for this purpose.	<input checked="" type="checkbox"/>	<input checked="" type="checkbox"/>	N/A
7	Repair, maintenance and storage			
	Repairs and maintenance shall be carried out by a competent person and be in accordance with the producer's instructions.			N/A
	For repair and replacement of parts, e.g. feet, if necessary contact the producer or distributor.			N/A
	Ladders should be stored in accordance with the producer's instructions.			N/A
	Ladders made of or using thermoplastic, thermosetting plastic and reinforced plastic materials should be stored out of direct sunlight.			N/A
	Ladders made of wood should be stored in a dry place and shall not be coated with opaque and vapour-tight paints.			N/A
ANEXO C	A-deviations			
	A-deviation for Sweden			N/A
	A-deviation for The Netherlands			N/A
	A-deviation for France			N/A

EN 131-1 + EN 131-2 + EN 131-3

FUNCTIONAL SIZES TABLES

MODEL: 8 STEPS				
STILES	ACCESS [mm]	SUPPORT [mm]	--	VEREDICT
Stile	49,9	33	49,9	---
t	19,97	20,18	19,97	---
DIMENSIONS	MINIMUM [mm]	MAXIMUM [mm]	MEASURED [mm]	VEREDICT
b1	280	---	300,4	P
b2 Access	514,34	---	514,9	P
b2 Support	514,34	---	516,5	P
DIMENSIONS	MINIMUM [mm]	MAXIMUM [mm]	MEASURED [mm]	VEREDICT
c	---	30	15	P
d	600	---	605	P
DIMENSIONS	MINIMUM [mm]	MAXIMUM [mm]	MEASURED [mm]	VEREDICT
l2	---	---	1740	---
l4	115	245	140	P
l5	230	300	230	P
l6	250	--	253	P
l7	250	--	253	P
ANGLES	MINIMUM [°]	MAXIMUM [°]	MEASURED [°]	VEREDICT
α	60	70	65,7	P
β	65	75	74,9	P
Equipments: I01/23; A15/002; D04/002; A11/002				

VARIANT: 7 STEPS				
STILES	ACCESS [mm]	SUPPORT [mm]	--	VEREDICT
t	19,91	20,3	20,3	---
DIMENSIONS	MINIMUM [mm]	MAXIMUM [mm]	MEASURED [mm]	VEREDICT
b1	280	---	300,1	P
b2 Access	491,42	---	493,9	P
b2 Support	491,42	---	491,2	P
DIMENSIONS	MINIMUM [mm]	MAXIMUM [mm]	MEASURED [mm]	VEREDICT
c	---	30	13	P
d	600	---	605	P
DIMENSIONS	MINIMUM [mm]	MAXIMUM [mm]	MEASURED [mm]	VEREDICT
l2	---	---	1515	---
l4	115	245	140	P
l5	230	300	230	P
l6	250	--	253	P
l7	250	--	253	P
ANGLES	MINIMUM [°]	MAXIMUM [°]	MEASURED [°]	VEREDICT
α	60	70	65,5	P
β	65	75	75,0	P
Equipments: I01/23; A15/002; D04/002; A11/002				

EN 131-1 + EN 131-2 + EN 131-3

FUNCTIONAL SIZES TABLES

VARIANT: 6 STEPS				
STILES	ACCESS [mm]	SUPPORT [mm]	--	VEREDICT
t	20,3	20,3	20,3	20,3
DIMENSIONS	MINIMUM [mm]	MAXIMUM [mm]	MEASURED [mm]	VEREDICT
b1	280	---	301,8	P
b2 Access	469,4	---	469,7	P
b2 Support	469,4	---	473,4	P
DIMENSIONS	MINIMUM [mm]	MAXIMUM [mm]	MEASURED [mm]	VEREDICT
c	---	30	13	P
d	600	---	605	P
DIMENSIONS	MINIMUM [mm]	MAXIMUM [mm]	MEASURED [mm]	VEREDICT
l2	---	---	1270	---
l4	115	245	140	P
l5	230	300	230	P
l6	250	--	253	P
l7	250	--	253	P
ANGLES	MINIMUM [°]	MAXIMUM [°]	MEASURED [°]	VEREDICT
α	60	70	65,8	P
β	65	75	75,0	P
Equipments: I01/23; A15/002; D04/002; A11/002				

VARIANT: 5 STEPS				
STILES	ACCESS [mm]	SUPPORT [mm]	--	VEREDICT
t	20,16	20,14	20,16	---
DIMENSIONS	MINIMUM [mm]	MAXIMUM [mm]	MEASURED [mm]	VEREDICT
b1	280	---	300,9	P
b2 Access	445,22	---	445,8	P
b2 Support	445,22	---	450,8	P
DIMENSIONS	MINIMUM [mm]	MAXIMUM [mm]	MEASURED [mm]	VEREDICT
c	---	30	13	P
d	600	---	605	P
DIMENSIONS	MINIMUM [mm]	MAXIMUM [mm]	MEASURED [mm]	VEREDICT
l2	---	---	1040	---
l4	115	245	140	P
l5	230	300	230	P
l6	250	--	253	P
l7	250	--	253	P
ANGLES	MINIMUM [°]	MAXIMUM [°]	MEASURED [°]	VEREDICT
α	60	70	65,7	P
β	65	75	74,1	P
Equipments: I01/23; A15/002; D04/002; A11/002				

EN 131-1 + EN 131-2 + EN 131-3

FUNCTIONAL SIZES TABLES

VARIANT: 4 STEPS				
STILES	ACCESS [mm]	SUPPORT [mm]	--	VEREDICT
t	20,08	20,05	20,08	---
DIMENSIONS	MINIMUM [mm]	MAXIMUM [mm]	MEASURED [mm]	VEREDICT
b1	280	---	300,9	P
b2 Access	422,06	---	423,5	P
b2 Support	422,06	---	429,9	P
DIMENSIONS	MINIMUM [mm]	MAXIMUM [mm]	MEASURED [mm]	VEREDICT
c	---	30	13	P
d	600	---	605	P
DIMENSIONS	MINIMUM [mm]	MAXIMUM [mm]	MEASURED [mm]	VEREDICT
l2	---	---	810	---
l4	115	245	140	P
l5	230	300	230	P
l6	250	--	253	P
l7	250	--	253	P
ANGLES	MINIMUM [°]	MAXIMUM [°]	MEASURED [°]	VEREDICT
α	60	70	64,7	P
β	65	75	75,0	P
Equipments: I01/23; A15/002; D04/002; A11/002				

VARIANT: 3 STEPS				
STILES	ACCESS [mm]	SUPPORT [mm]	--	VEREDICT
t	20,2	20,1	20,2	---
DIMENSIONS	MINIMUM [mm]	MAXIMUM [mm]	MEASURED [mm]	VEREDICT
b1	280	---	300,8	P
b2 Access	400,7	---	400,9	P
b2 Support	400,7	---	405,1	P
DIMENSIONS	MINIMUM [mm]	MAXIMUM [mm]	MEASURED [mm]	VEREDICT
c	---	30	13	P
d	600	---	605	P
DIMENSIONS	MINIMUM [mm]	MAXIMUM [mm]	MEASURED [mm]	VEREDICT
l2	---	---	595	---
l4	115	245	140	P
l5	230	300	230	P
l6	250	--	253	P
l7	250	--	253	P
ANGLES	MINIMUM [°]	MAXIMUM [°]	MEASURED [°]	VEREDICT
α	60	70	65,0	P
β	65	75	75,0	P
Equipments: I01/23; A15/002; D04/002; A11/002				

EN 131-1 + EN 131-2 + EN 131-3

FUNCTIONAL SIZES TABLES

VARIANT: 2 STEPS				
STILES	ACCESS [mm]	SUPPORT [mm]	--	VEREDICT
t	20,1	20,1	20,1	---
DIMENSIONS	MINIMUM [mm]	MAXIMUM [mm]	MEASURED [mm]	VEREDICT
b1	280	---	300,9	P
b2 Access	377,6	---	378,0	P
b2 Support	377,6	---	380,4	P
DIMENSIONS	MINIMUM [mm]	MAXIMUM [mm]	MEASURED [mm]	VEREDICT
c	---	30	13	P
d	600	---	605	P
DIMENSIONS	MINIMUM [mm]	MAXIMUM [mm]	MEASURED [mm]	VEREDICT
l2	---	---	365	---
l4	115	245	140	P
l5	230	300	230	P
l6	250	--	253	P
l7	250	--	253	P
ANGLES	MINIMUM [°]	MAXIMUM [°]	MEASURED [°]	VEREDICT
α	60	70	65,8	P
β	65	75	74,6	P
Equipments: I01/23; A15/002; D04/002; A11/002				

Note:

Rungs overlap:

Ladder	No. of rungs	Overlap
---	---	---

FIGURES

MARKING PLATES

MODEL:

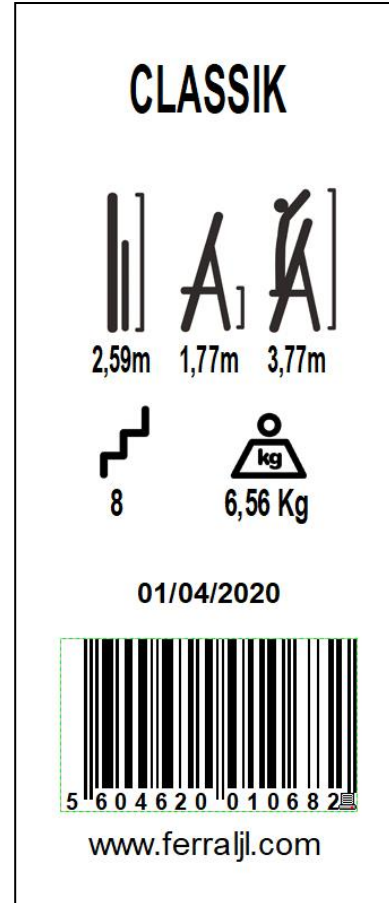

FIGURES

VARIANTS:

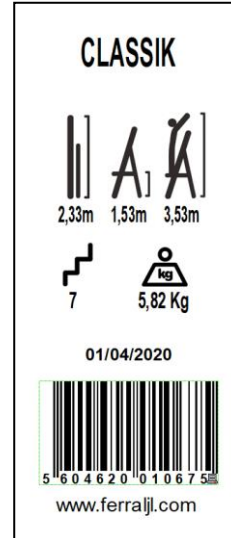
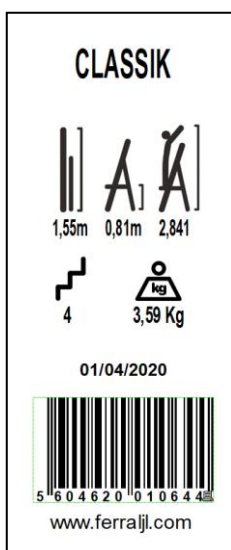
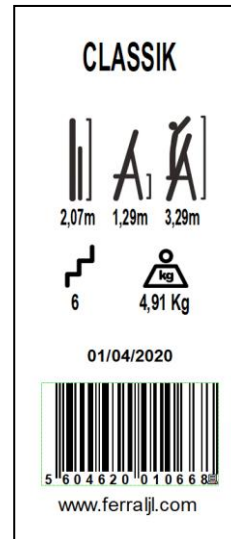
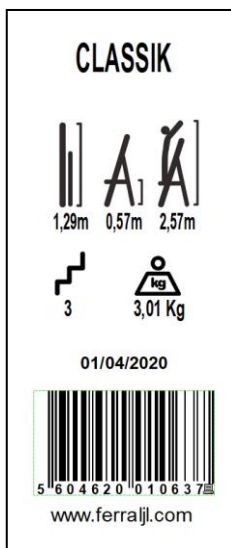
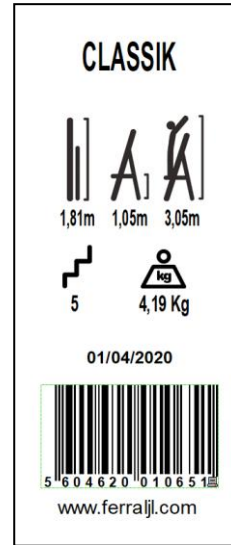
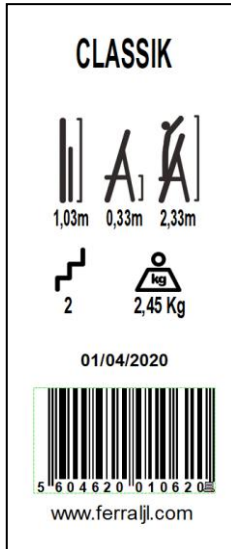

FIGURES

FIGURES

MODEL:



FIGURES

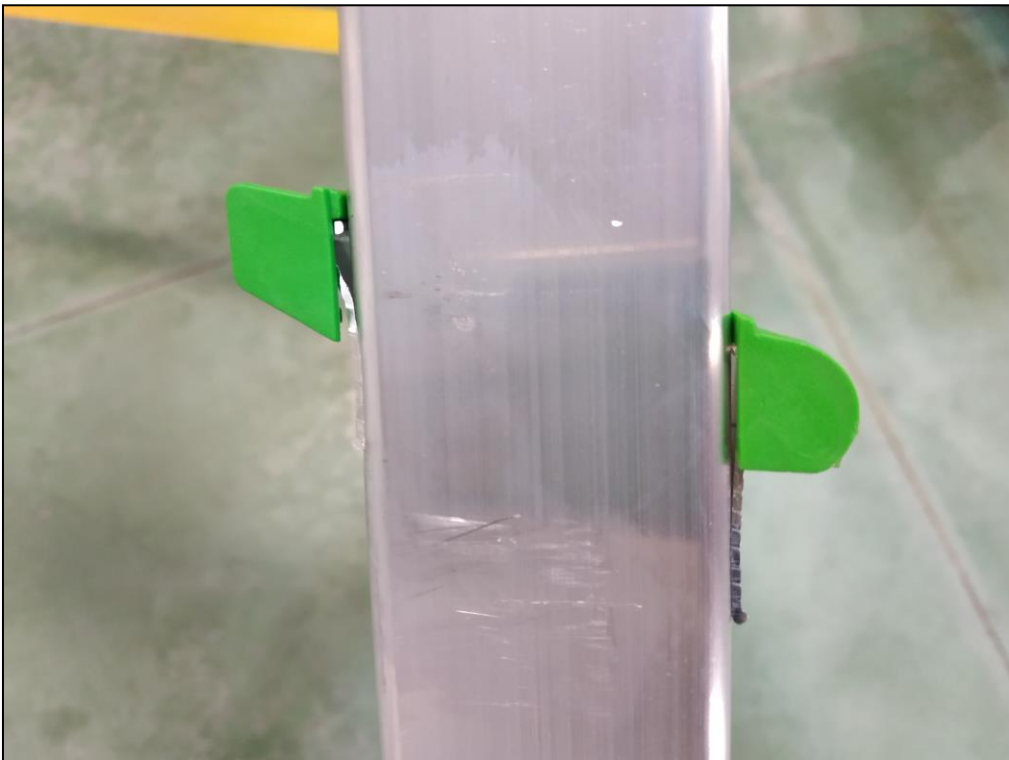

FIGURES

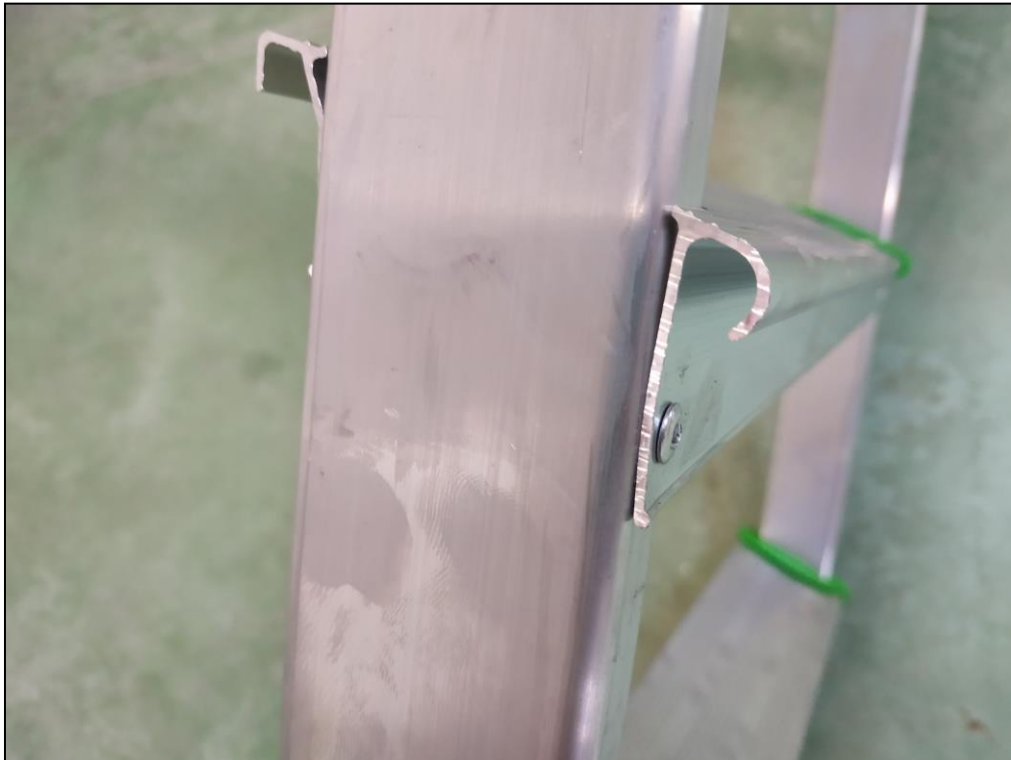

FIGURES



FIGURES



FIGURES



FIGURES

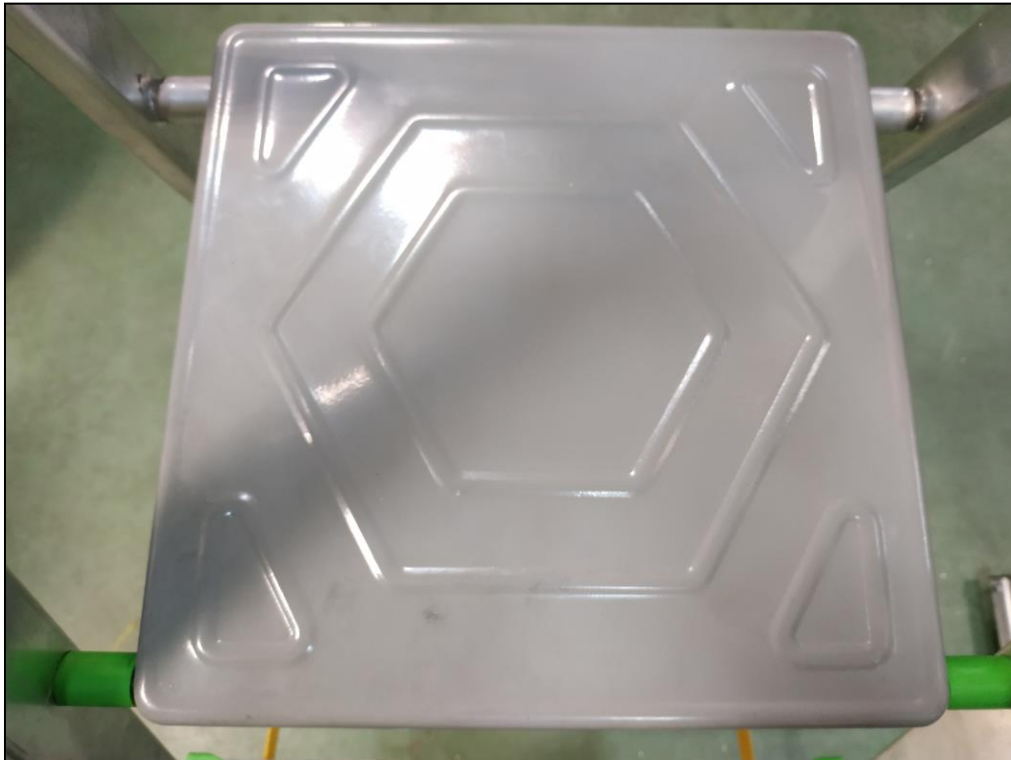

FIGURES

VARIANTS:



FIGURES



FIGURES



FIGURES



FIGURES



FIGURES

